

## POLY V KAYIŞ KASNAKLARI

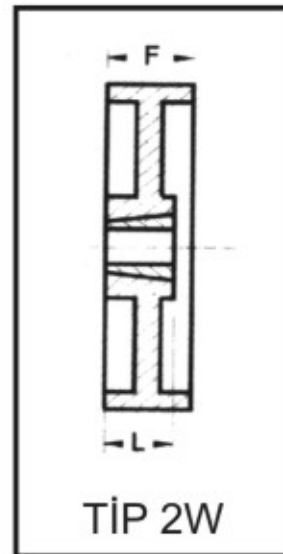
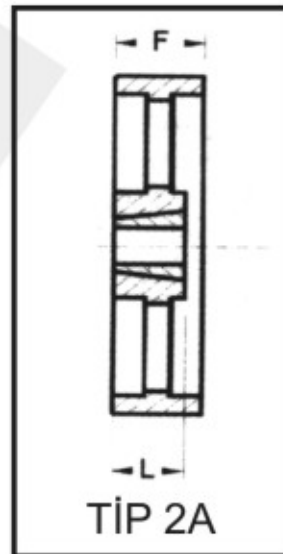
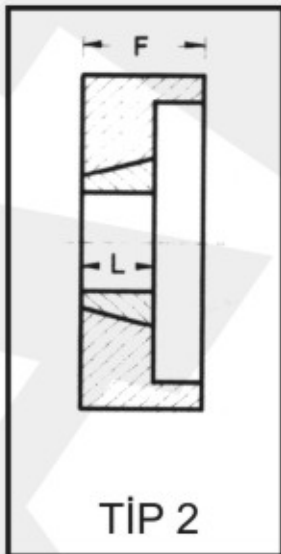
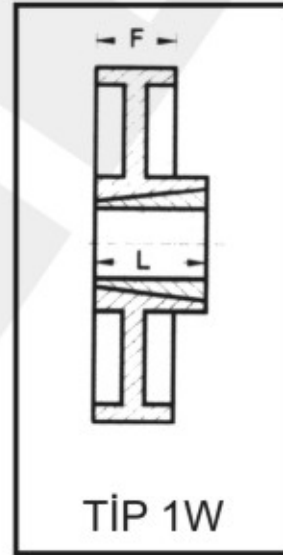
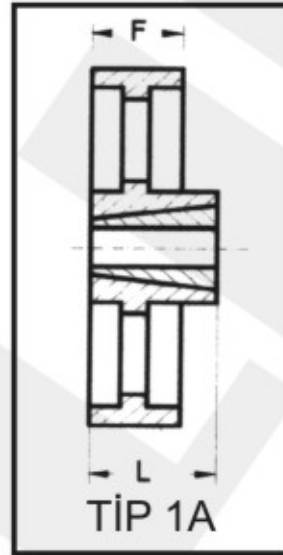
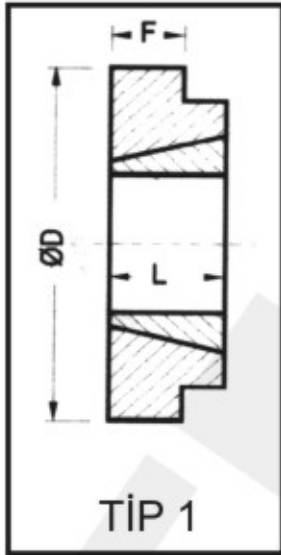

# BURÇLU POLY-V KAYIŞ KASNAKLARI

## AVANTAJLARI

### POLY-V KASNAKLARIN AVANTAJLARI

Çok sayıda ve ince V kanalları olan kasnaklardır. Kanal derinlikleri azdır. Kayış olarak kasnaktaki kanal sayısı kadar kanal çokluğunda tek kayış kullanılır. Bu nedenle her kanala eşit gergi kuvveti geleceğinden Kayıp % 2 ila % 5 arası olmaktadır. Bu da hem kayışın hem de kasnağın ömrünü uzatır. Poly-V kasnaklarda kayışın bütün yüzeyi sarması nedeniyle tutunma kuvvetli, kayma az olur.

Poly-v kasnaklarda derinlik azdır. Bu nedenle küçük çaplarda imal edilebilmektedir. Örneğin; çapı 50 mm olan kamalı mile 75 mm çapında Poly-V kasnak takılabilir. Devri 6 kat azaltmak istersek kasnak çapı 450mm olmalıdır. Böylelikle makina rahatlar ve hantalıktan kurtulur.

Küçük güç ve yüksek devirlerde kullanılan tipleri olduğu gibi büyük güç iletebilen (400KW-1000 Dev DM) tipleri de mevcuttur. Bunlar ince dişten kalın dişe doğru sırayla PH, PJ, PK, PL, PM olarak adlandırılır. Poly-V kasnaklar en az 4 sıra en çok 36 sıralı olarak yapılırlar. Örneğin; PK120/12 'de ; PK Kasnağın kanal tipini, 120 kasnağın çapını, 12 kasnağın kanal sayısını belirtir.

Hangi güç, hangi devirde hangi tip Poly-V kasnak kullanmamız gerektiği diyagramdan seçilir. (Syf. 36)

Örneğin; 200KW1000 devir için PM 16 Poly-V kasnak kullanmak gerekir. Bu kasnağın eni: 158mm olur. Aynı işi V kayış kasnağıyla yapmak istesek DIN 2211 standardıda işlenmiş SPC (22'lik kasnak) 10 kanallı kasnak kullanmak gerekir. Bu kasnağın eni: 263. mm dir.

Bu durumda Poly-V kasnak kullanıldığında çap %40 küçülürken eninden de %40 küçülmektedir. Kasnak eninin küçülmesi makinanın yatakları ve bazı fonksiyonlarını çok etkilediği için önemlidir.



## DEZAVANTAJLARI

### POLY-V KASNAKLARIN DEZAVANTAJLARI

1- Poly-v kasnak kullanımı hızla yayıldığı için kayışları da kolay bulunabilmektedir. Ancak kayışlarının ithal olmasından dolayı fiyatları yüksek olabilmektedir.

2- Poly-V kasnakların işçiliği hassas ve önemlidir. Konuyu ve işi iyi bilen kişi yada kişilerin kontrolünde üretilmesi gerekir. V kasnaklarda olduğu gibi sadece benzetmek yeterli olmaz. İmalatda gerekli şartların yerine getirilmesi şarttır. Uygun şartlarda kaliteli üretilen kasnakla uygun olmayan şartlarda kalitesiz üretilen kasnağı ayırt etmek çok zordur. Kaliteyi Poly-V kasnakta kayış 3 yıl gidiyorsa kalitesiz Poly-V kasnakta kayış ancak 3 ay dayanır.

## POLY V- KANALLI KAYIŞ TIPLERİ

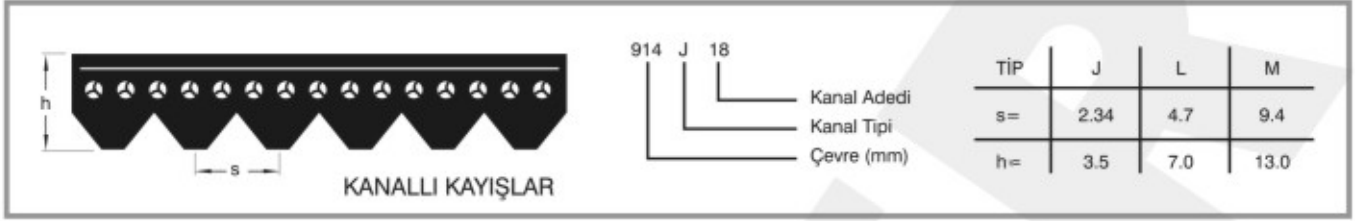

## BURÇLU POLY-V KAYIŞ KASNAKLARI

### MOTOR GÜCÜ VE DEVİR SAYISINA GÖRE POLY-V KASNAK SEÇİMİ

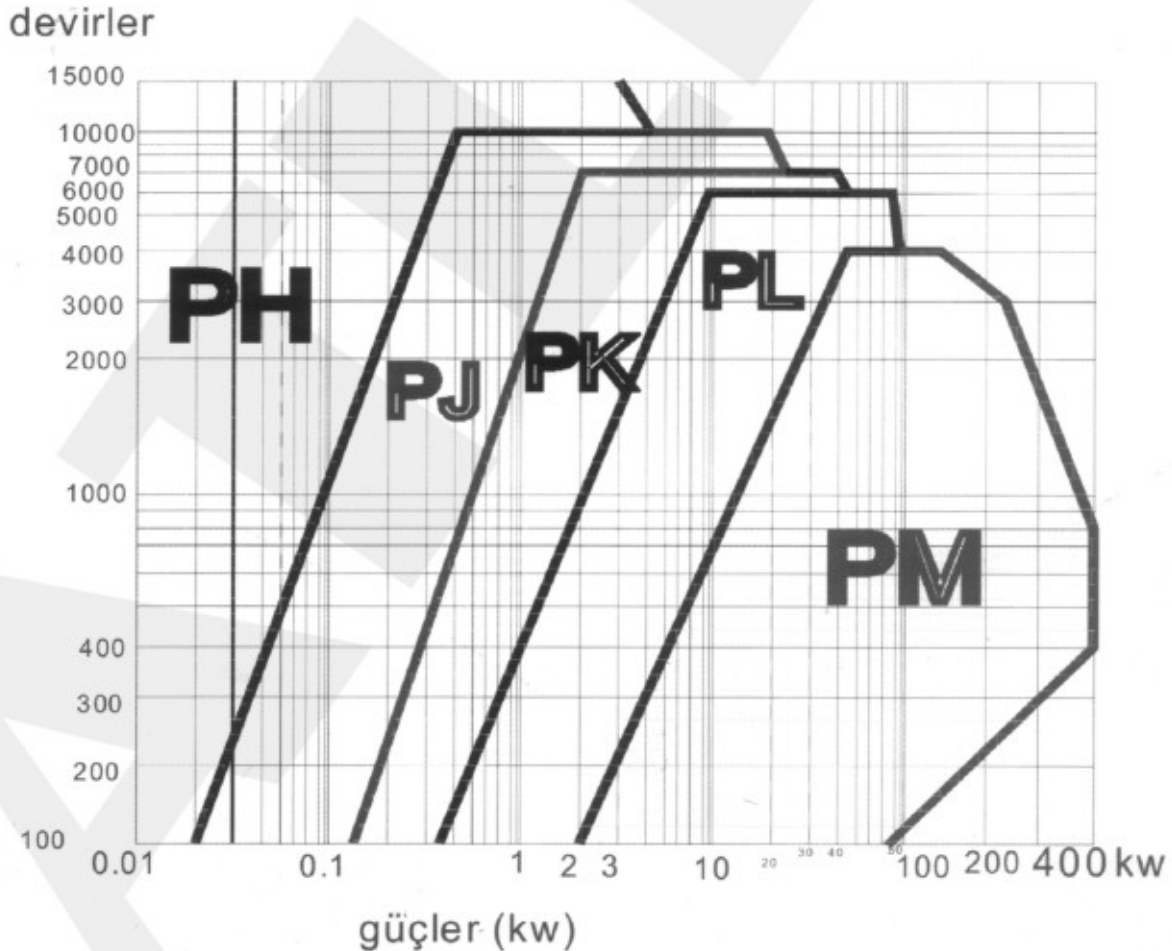

## POLY V KAYIŞ KASNAKLARI

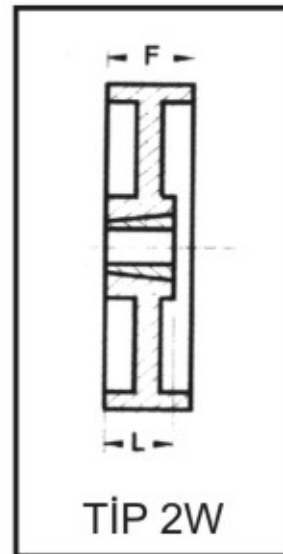
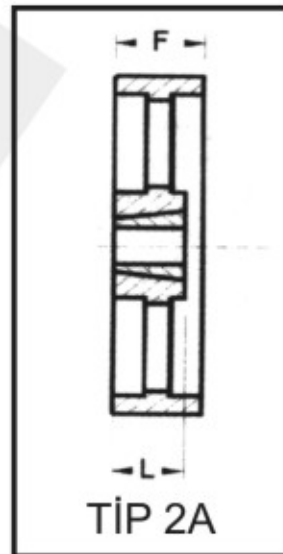
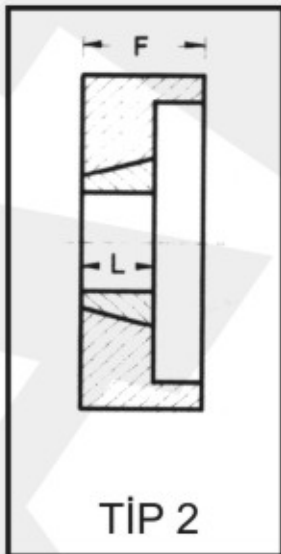
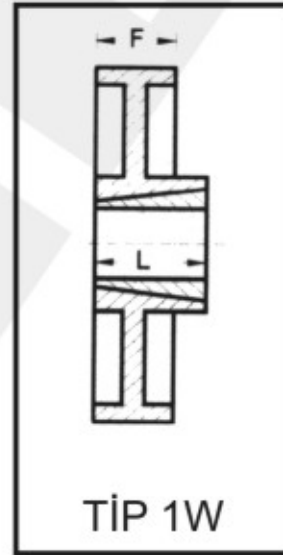
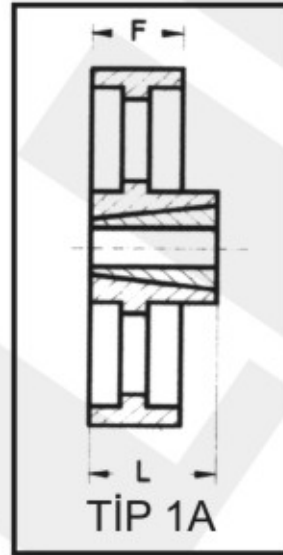
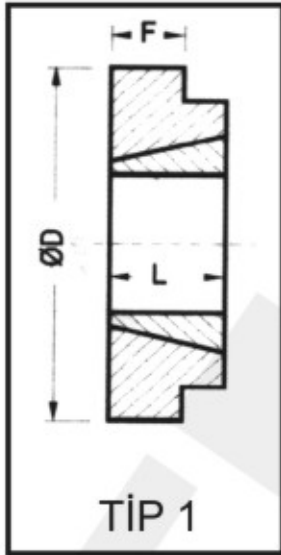

# BURÇLU® POLY-V KAYIŞ KASNAKLARI

## PJ PROFİLLİ BURÇLU POLY-V KASNAKLAR

PJ 4 KANAL / PJ 4 GROOVE				
Çap / Diameter	Tip / Type	Burç no/ Taper bush	F	L
55	1	1008	14	22
60	1	1008	14	22
70	1	1108	14	22
80	1	1108	14	22
90	1	1108	14	22
100	1	1210	14	25
110	1	1210	14	25
125	1	1610	14	25
140	1	1610	14	25
150	1	1610	14	25
160	1	1610	14	25
170	1W	1610	14	25
180	1W	1610	14	25
190	1W	1610	14	25
200	1W	1610	14	25
210	1W	1610	14	25
220	1W	1610	14	25
250	1W	2012	14	31
300	1A	2012	14	31
400	1A	2517	14	45
500	1A	2517	14	45

PJ 8 KANAL / PJ 8 GROOVE				
Çap / Diameter	Tip / Type	Burç no/ Taper bush	F	L
55	2	1008	24	22
60	2	1008	24	22
70	2	1108	24	22
80	2	1108	24	22
90	1	1210	24	25
100	1	1210	24	25
110	1	1610	24	25
125	1	1610	24	25
140	1	1610	24	25
150	1	1610	24	25
160	1	1610	24	25
170	1W	1610	24	25
180	1W	1610	24	25
190	1W	1610	24	25
200	1W	2012	24	31
210	1W	2012	24	31
220	1W	2012	24	31
250	1W	2012	24	31
300	1A	2012	24	31
400	1A	2517	24	45
500	1A	2517	24	45

## PJ PROFİLLİ BURÇLU POLY-V KASNAKLAR

PJ 12 KANAL / PJ 12 GROOVE				
Çap / Diameter	Tip / Type	Burç no/ Taper bush	F	L
70	2	1108	33	22
80	2	1210	33	22
90	2	1610	33	22
100	2	1610	33	25
110	2	1610	33	25
125	2	1610	33	25
140	2	1610	33	25
150	2	1610	33	25
160	2	1610	33	25
170	2	1610	33	25
180	2W	1610	33	25
190	2W	1610	33	25
200	2W	2012	33	31
210	2W	2012	33	31
220	2W	2012	33	31
250	2W	2012	33	31
300	2A	2012	33	31
400	1A	2517	33	45
500	1A	2517	33	45

PJ 16 KANAL / PJ 16 GROOVE				
Çap / Diameter	Tip / Type	Burç no/ Taper bush	F	L
80	2	1210	43	22
90	2	1610	43	25
100	2	1610	43	25
110	2	1610	43	25
125	2	2012	43	31
140	2	2012	43	31
150	2	2012	43	31
160	2	2012	43	31
170	2	2012	43	31
180	2W	2012	43	31
190	2W	2012	43	31
200	2W	2012	43	31
210	2W	2012	43	31
220	2W	2012	43	31
250	2W	2012	43	31
300	2W	2012	43	31
400	2A	2517	43	45
500	1A	2517	43	45

## POLY V KAYIŞ KASNAKLARI

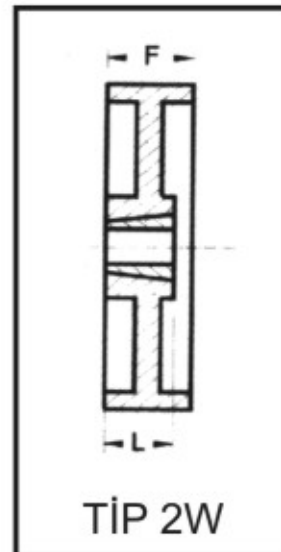
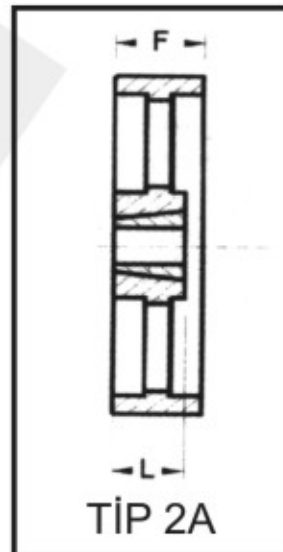
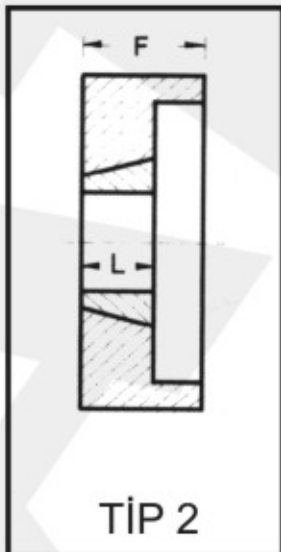
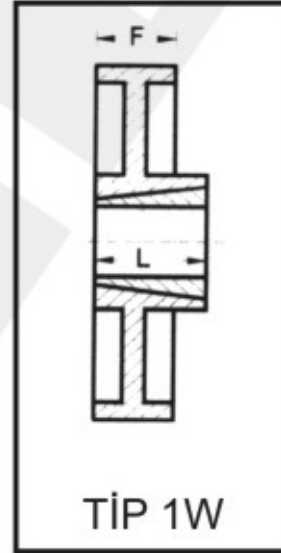
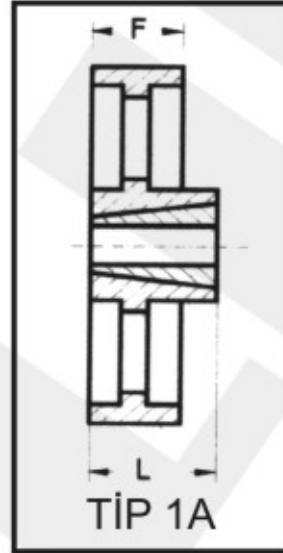
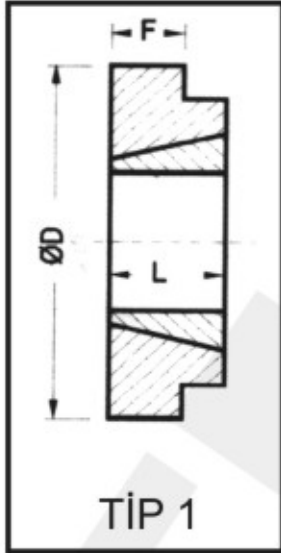

# BURÇLU® POLY-V KAYIŞ KASNAKLARI

## PK PROFİLLİ BURÇLU POLY-V KASNAKLAR

PK 4 KANAL / PK 4 GROOVE				
Çap / Diameter	Tip / Type	Burç no/ Taper bush	F	L
60	1	1108	22	22
70	1	1108	22	22
80	1	1108	22	22
90	1	1108	22	22
100	1	1210	22	25
110	1	1610	22	25
125	1	1610	22	25
140	1	1610	22	25
150	1	1610	22	25
160	1	1610	22	25
170	1	1610	22	25
180	1W	1610	22	25
190	1W	1610	22	25
200	1W	1610	22	25
210	1W	1610	22	25
220	1W	1610	22	25
250	1W	2012	22	31
300	1A	2012	22	31
400	1A	2517	22	45
500	1A	3020	22	51

PK 8 KANAL / PK 8 GROOVE				
Çap / Diameter	Tip / Type	Burç no/ Taper bush	F	L
60	2	1108	36	22
70	2	1108	36	22
80	2	1108	36	22
90	2	1210	36	25
100	2	1610	36	25
110	2	1610	36	25
125	2	1610	36	25
140	2	1610	36	25
150	2	1610	36	25
160	2	1610	36	25
170	2	1610	36	25
180	2W	1610	36	25
190	2W	1610	36	25
200	2W	2012	36	31
210	2W	2012	36	31
220	2W	2012	36	31
250	2W	2012	36	31
300	1A	2517	36	45
400	1A	3020	36	45
500	1A	3020	36	51

## PK PROFİLLİ BURÇLU POLY-V KASNAKLAR

PK 12 KANAL / PK 12 GROOVE				
Çap / Diameter	Tip / Type	Burç no/ Taper bush	F	L
70	2	1108	50	22
80	2	1210	50	22
90	2	1610	50	22
100	2	1610	50	25
110	2	1610	50	25
125	2	1610	50	25
140	2	1610	50	25
150	2	1610	50	25
160	2W	1610	50	25
170	2W	1610	50	25
180	2W	1610	50	25
190	2W	1610	50	25
200	2W	2012	50	31
210	2W	2012	50	31
220	2W	2012	50	31
250	2W	2517	50	45
300	2A	2517	50	45
400	1A	3020	50	51
500	1A	3535	50	90

PK 16 KANAL / PK 16 GROOVE				
Çap / Diameter	Tip / Type	Burç no/ Taper bush	F	L
80	2	1210	65	22
90	2	1610	65	25
100	2	1610	65	25
110	2	2012	65	31
125	2	2012	65	31
140	2	2012	65	31
150	2	2012	65	31
160	2	2012	65	31
170	2	2012	65	31
180	2W	2012	65	31
190	2W	2012	65	31
200	2W	2012	65	31
210	2W	2012	65	31
220	2W	2012	65	31
250	2W	2517	65	45
300	2A	2517	65	45
400	2A	3020	65	51
500	1A	3535	65	90

## POLY V KAYIŞ KASNAKLARI

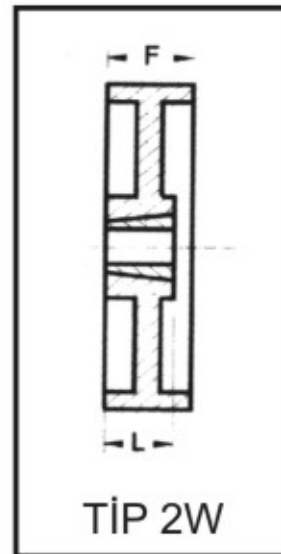
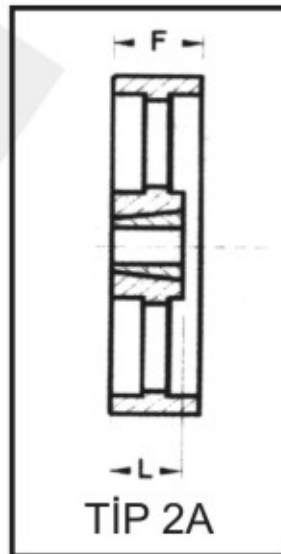
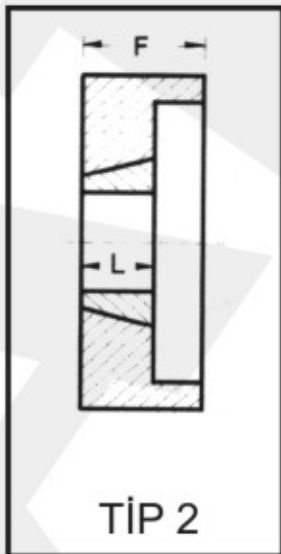
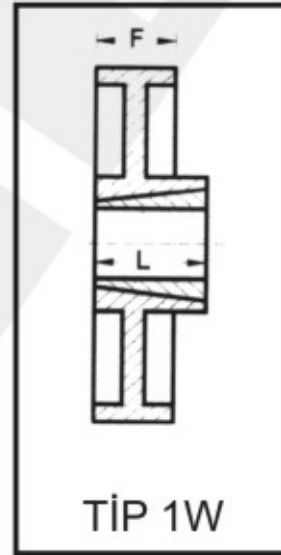
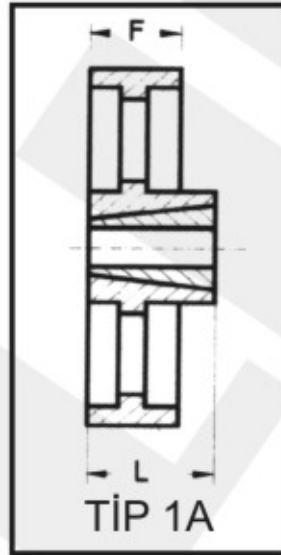
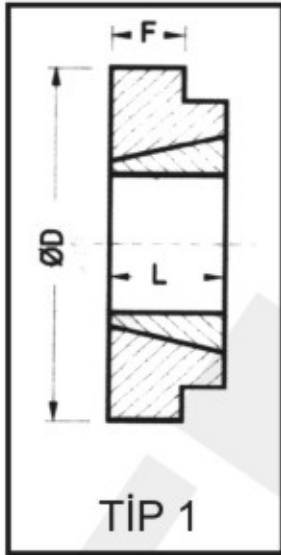
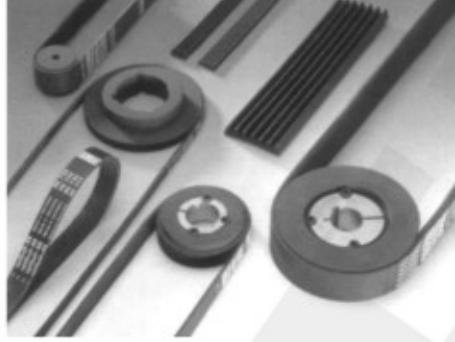



# BURÇLU® POLY-V KAYIŞ KASNAKLARI

## PL PROFİLLİ BURÇLU POLY-V KASNAKLAR

PL BURÇLU POLY-V KASNAKLAR									
PL 4 KANAL / PL 4 GROOVE					PL 8 KANAL / PL 8 GROOVE				
Çap / Diameter	Tip / Type	Burç no / Taper bush	F	L	Çap / Diameter	Tip / Type	Burç no / Taper bush	F	L
60	2	1008	29	22	80	2	1108	48	22
70	2	1108	29	22	90	2	1610	48	25
80	2	1108	29	22	100	2	1610	48	25
90	2	1108	29	22	110	2	1610	48	25
100	2	1610	29	25	125	2	2012	48	31
110	2	1610	29	25	140	2	2012	48	31
125	2	1610	29	25	150	2	2012	48	31
140	2	1610	29	25	160	2	2012	48	31
150	2	1610	29	25	170	2	2012	48	31
160	2	1610	29	25	180	2	2012	48	31
170	2W	1610	29	25	190	2W	2012	48	31
180	1W	2012	29	31	200	2W	2012	48	31
190	1W	2012	29	31	210	1W	2012	48	31
200	1W	2012	29	31	220	1W	2012	48	31
210	1W	2012	29	31	250	1W	2012	48	31
220	1W	2012	29	31	300	2A	2517	48	45
250	1A	2012	29	31	400	1A	3020	48	51
300	1A	2012	29	31	500	1A	3020	48	51
400	1A	2517	29	45					
500	1A	3020	29	51					

## PL PROFİLLİ BURÇLU POLY-V KASNAKLAR

PL 12 KANAL / PL 12 GROOVE					PL 16 KANAL / PL 16 GROOVE				
Çap / Diameter	Tip / Type	Burç no / Taper bush	F	L	Çap / Diameter	Tip / Type	Burç no / Taper bush	F	L
100	2	1610	66	25	110	2	1615	85	35
110	2	1610	66	25	125	2	2517	85	45
125	2	2012	66	31	140	2	2517	85	45
140	2	2012	66	31	150	2	3020	85	51
150	2	2517	66	45	160	2	3020	85	51
160	2	2517	66	45	170	2	3020	85	51
170	2	2517	66	45	180	2	3020	85	51
180	2	2517	66	45	190	2	3020	85	51
190	2	2517	66	45	200	2	3020	85	51
200	2W	2517	66	45	210	2W	3020	85	51
210	2W	2517	66	45	220	2W	3020	85	51
220	2W	2517	66	45	250	2W	3020	85	51
250	2W	2517	66	45	300	1W	3535	85	90
300	2A	2517	66	45	400	1A	3535	85	90
400	2A	3020	66	51	500	1A	3535	85	90
500	1A	3535	66	90					

## POLY V KAYIŞ KASNAKLARI

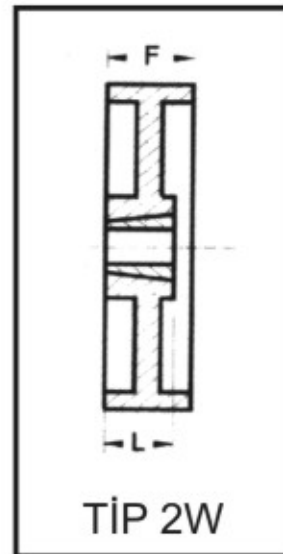
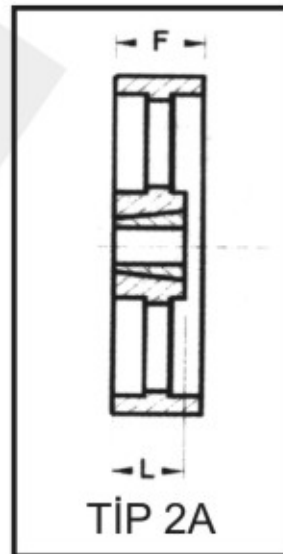
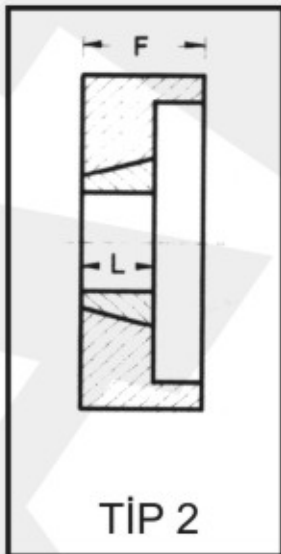
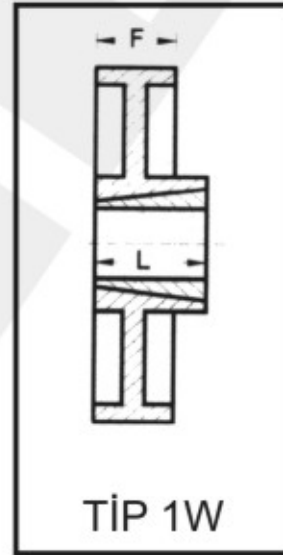
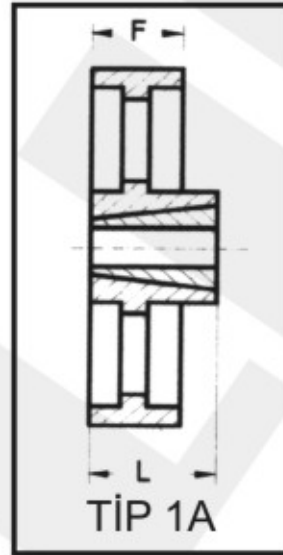
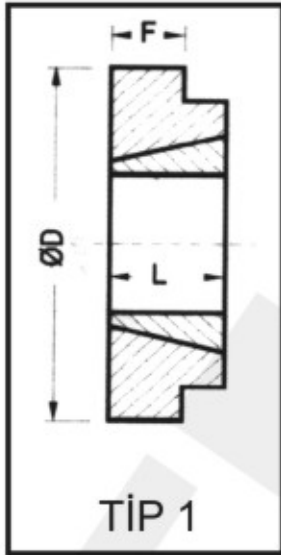

# BURÇLU® POLY-V KAYIŞ KASNAKLARI

## PM PROFİLLİ BURÇLU POLY-V KASNAKLAR

### PM 8 KANAL / PM 8 GROOVE

ÇAP Diameter	TIP Type	BURÇ NO Bush	F	L
170	2	2517	94	46
180	2	2517	94	46
190	2	2517	94	46
200	2	3020	94	51
210	2	3020	94	51
220	2	3020	94	51
230	2W	3020	94	51
250	2W	3020	94	51
280	2W	3535	94	89
315	2W	3535	94	89
355	2W	3535	94	89
400	2A	3535	94	89
500	1A	4040	94	100
630	1A	5050	94	125
800	1A	5050	94	125

### PM 16 KANAL / PM 16 GROOVE

ÇAP Diameter	TIP Type	BURÇ NO Bush	F	L
170	2	3020	170	51
180	2	3020	170	51
190	2	3020	170	51
200	2	3020	170	76
210	2	3020	170	76
220	2	3020	170	76
230	2W	3020	170	76
250	2W	3535	170	89
280	2W	3535	170	89
315	2W	3535	170	89
355	2W	3535	170	100
400	2A	3535	170	100
500	2A	3535	170	125
630	2A	5050	170	125
800	2A	5050	170	125

### PM 12 KANAL / PM 12 GROOVE

ÇAP Diameter	TIP Type	BURÇ NO Bush	F	L
170	2	3020	132	51
180	2	3020	132	51
190	2	3020	132	51
200	2	3020	132	51
210	2	3020	132	51
220	2	3020	132	51
230	2W	3020	132	51
250	2W	3535	132	89
280	2W	3535	132	89
315	2W	3535	132	89
355	2W	3535	132	89
400	2A	3535	132	89
500	2A	4040	132	100
630	2A	5050	132	125
800	2A	5050	132	125

### PM 20 KANAL / PM 20 GROOVE

ÇAP Diameter	TIP Type	BURÇ NO Bush	F	L
170	2	3020	207	51
180	2	3020	207	51
190	2	3030	207	76
200	2	3030	207	76
210	2	3030	207	76
220	2	3030	207	76
230	2W	3030	207	76
250	2W	3535	207	89
280	2W	3535	207	89
315	2W	3535	207	89
355	2W	4040	207	100
400	2A	4040	207	100
500	2A	4545	207	115
630	2A	5050	207	125
800	2A	5050	207	125

# BURÇLU® KASNAK TIPLERİ

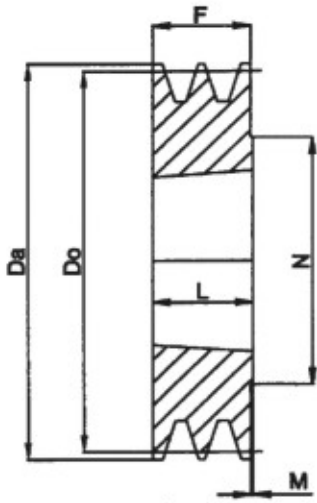

TİP 1

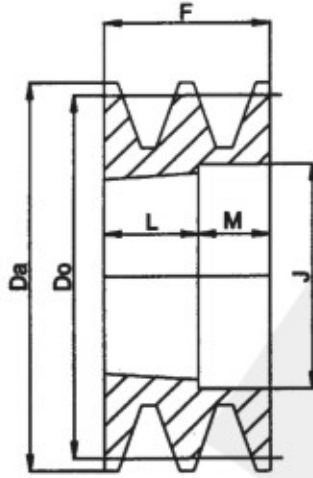

TİP 2

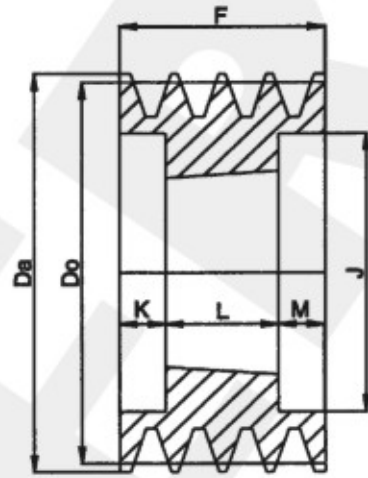

TİP 3

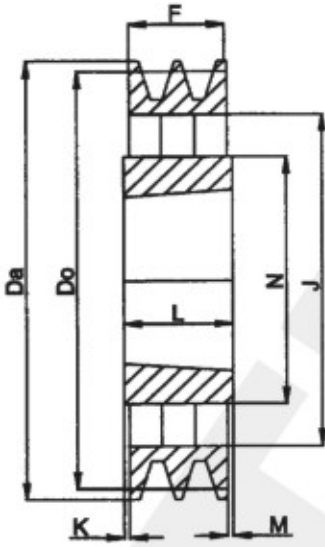

TİP 4

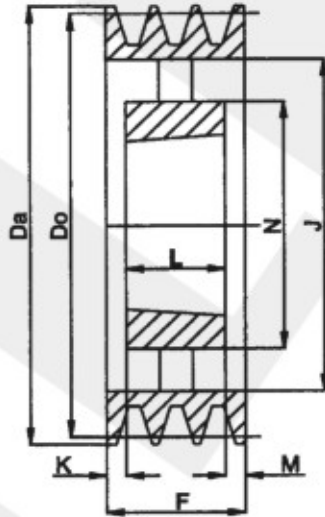

TİP 5

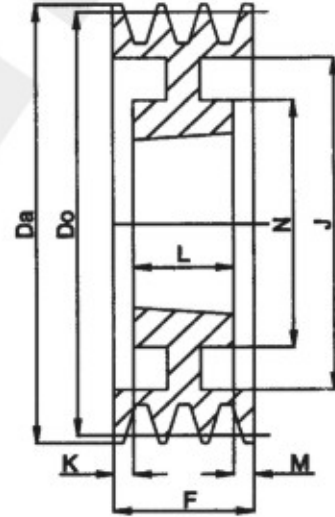

TİP 6

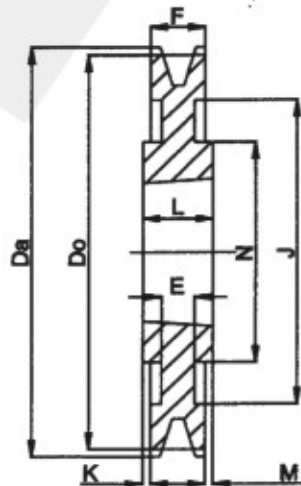

TİP 7



# BURÇLU® KASNAKLAR

## SPA (12,5 - 13)

Parça No	Anma Çapı Do	Dış Çapı Da	Kanal No	Burç No	Max. Delik	Kasnak Tipi	F	L
SPA 63/1	63	68.5	1	1108	28	1	40	22
63/2	63	68.5	2	1108	28	2	55	22
SPA 67/1	67	72.5	1	1108	28	1	20	22
67/2	67	72.5	2	1108	28	2	35	22
SPA 71/1	71	76.5	1	1108	28	1	20	22
71/2	71	76.5	2	1108	28	2	35	22
71/3	71	76.5	3	1108	28	2	50	22
SPA 75/1	75	80.5	1	1108	28	1	20	22
75/2	75	80.5	2	1108	28	2	35	22
75/3	75	80.5	3	1108	28	2	50	22
SPA 80/1	80	85.5	1	1108	28	1	20	22
80/2	80	85.5	2	1108	28	2	35	22
80/3	80	85.5	3	1108	28	2	50	22
SPA 85/1	85	90.5	1	1210	32	1	20	25
85/2	85	90.5	2	1210	32	2	35	25
85/3	85	90.5	3	1210	32	2	50	25
SPA 90/1	90	95.5	1	1210	32	1	20	25
90/2	90	95.5	2	1610	42	2	35	25
90/3	90	95.5	3	1610	42	2	50	25
90/4	90	95.5	4	1610	42	3	65	38
SPA 95/1	95	100.5	1	1210	32	1	20	25
95/2	95	100.5	2	1610	42	2	35	25
95/3	95	100.5	3	1610	42	2	50	25
95/4	95	100.5	4	1615	42	2	65	38
SPA 100/1	100	105.5	1	1610	42	1	20	25
100/2	100	105.5	2	1610	42	2	35	25
100/3	100	105.5	3	1610	42	2	50	25
100/4	100	105.5	4	1615	42	2	65	38
100/5	100	105.5	5	1615	42	2	80	38
100/6	100	105.5	6	1615	42	3	95	38
SPA 106/1	106	111.5	1	1610	42	1	20	25
106/2	106	111.5	2	1610	42	2	35	25
106/3	106	111.5	3	1610	42	2	50	25
106/4	106	111.5	4	2012	50	2	65	32
106/5	106	111.5	5	2012	50	2	80	32
106/6	106	111.5	6	2012	50	2	95	32
SPA 112/1	112	117.5	1	1610	42	1	20	25
112/2	112	117.5	2	1610	42	2	35	25
112/3	112	117.5	3	2012	50	2	50	32
112/4	112	117.5	4	2012	50	2	65	32
112/5	112	117.5	5	2012	50	2	80	32
112/6	112	117.5	6	2012	50	2	95	32
SPA 118/1	118	123.5	1	1610	42	1	20	25
118/2	118	123.5	2	1610	42	2	35	25
118/3	118	123.5	3	2012	50	2	50	32
118/4	118	123.5	4	2012	50	2	65	32
118/5	118	123.5	5	2012	50	2	80	32
118/6	118	123.5	6	2012	50	2	95	32
SPA 125/1	125	130.5	1	1610	42	1	20	25
125/2	125	130.5	2	1610	42	2	35	25
125/3	125	130.5	3	2012	50	2	50	32
125/4	125	130.5	4	2012	50	2	65	32
125/5	125	130.5	5	2012	50	3	80	32
125/6	125	130.5	6	2012	50	3	95	32

## SPA (12,5 - 13)

Parça No	Anma Çapı Do	Dış Çapı Da	Kanal No	Burç No	Max. Delik	Kasnak Tipi	F	L
SPA 132/1	132	137.5	1	1610	42	1	20	25
132/2	132	137.5	2	2012	50	2	35	32
132/3	132	137.5	3	2012	50	2	50	32
132/4	132	137.5	4	2517	60	2	65	45
132/5	132	137.5	5	2517	60	3	80	45
132/6	132	137.5	6	2517	60	3	95	45
SPA 140/1	140	145.5	1	1610	42	1	20	25
140/2	140	145.5	2	2012	50	2	35	32
140/3	140	145.5	3	2517	60	2	50	45
140/4	140	145.5	4	2517	60	2	65	45
140/5	140	145.5	5	2517	60	3	80	45
140/6	140	145.5	6	2517	60	3	95	45
SPA 150/1	150	155.5	1	1610	42	1	20	25
150/2	150	155.5	2	2012	50	2	35	32
150/3	150	155.5	3	2517	60	2	50	45
150/4	150	155.5	4	2517	60	2	65	45
150/5	150	155.5	5	2517	60	3	80	45
150/6	150	155.5	6	2517	60	3	95	45
SPA 160/1	160	165.5	1	1610	42	1	20	25
160/2	160	165.5	2	2012	50	3	35	32
160/3	160	165.5	3	2517	60	2	50	45
160/4	160	165.5	4	2517	60	2	65	45
160/5	160	165.5	5	2517	60	3	80	45
160/6	160	165.5	6	2517	60	3	95	45
SPA 170/1	170	175.5	1	1610	42	1	20	25
170/2	170	175.5	2	2012	50	3	35	32
170/3	170	175.5	3	2517	60	2	50	45
170/4	170	175.5	4	2517	60	2	65	45
SPA 180/1	180	185.5	1	1610	42	1	20	25
180/2	180	185.5	2	2012	50	6	35	32
180/3	180	185.5	3	2517	60	2	50	45
180/4	180	185.5	4	2517	60	2	65	45
180/5	180	185.5	5	3020	75	3	80	51
180/6	180	185.5	6	3020	75	3	95	51
SPA 190/1	190	195.5	1	1610	42	1	20	25
190/2	190	195.5	2	2012	50	6	350	32
190/3	190	195.5	3	2517	60	2	50	45
190/4	190	195.5	4	2517	60	2	65	45
SPA 200/1	200	205.5	1	2012	50	7	20	32
200/2	200	205.5	2	2517	60	7	35	45
200/3	200	205.5	3	2517	60	6	50	45
200/4	200	205.5	4	3020	75	2	65	51
200/5	200	205.5	5	3020	75	3	80	51
200/6	200	205.5	6	3020	75	3	95	51
224/1	224	229.5	1	2012	50	7	20	32
224/2	224	229.5	2	2517	60	7	35	45
224/3	224	229.5	3	2517	60	6	50	45
224/4	224	229.5	4	3020	75	2	65	51
224/5	224	229.5	5	3020	75	2	80	51
224/6	224	229.5	6	3020	75	3	95	51
SPA 236/1	236	241.5	1	2012	50	7	20	32
236/2	236	241.5	2	2517	60	7	35	45
236/3	236	241.5	3	2517	60	6	50	45
236/4	236	241.5	4	3020	75	3	65	51
236/5	236	241.5	5	3020	75	3	80	51

**KATALOGTA BULUNMAYAN ÖLÇÜLER İÇİN İMALAT İMKANIMIZ MEVCUTTUR**

**SPA (12,5 - 13)**

Parça No	Anma Çapı Do	Dış Çapı Da	Kanal No	Burç No	Max. Delik	Kasnak Tipi	F	L
SPA 250/1	250	255.5	1	2012	50	7	20	32
250/2	250	255.5	2	2517	60	7	35	45
250/3	250	255.5	3	2517	60	6	50	45
250/4	250	255.5	4	3020	75	6	65	51
250/5	250	255.5	5	3020	75	6	80	51
250/6	250	255.5	6	3020	75	6	95	51
SPA 280/1	280	285.5	1	2012	50	7	20	32
280/2	280	285.5	2	2517	60	7	35	45
280/3	280	285.5	3	2517	60	6	50	45
280/4	280	285.5	4	3020	75	6	65	51
280/5	280	285.5	5	3535	90	7	80	89
280/6	280	285.5	6	3535	90	6	95	89
SPA 300/1	300	305.5	1	2012	50	7	20	32
300/2	300	305.5	2	2517	60	7	35	45
300/3	300	305.5	3	3020	75	7	50	51
300/4	300	305.5	4	3020	75	6	65	51
300/5	300	305.5	5	3535	90	7	80	89
SPA 315/1	315	320.5	1	2012	50	4	20	32
315/2	315	320.5	2	2517	60	4	35	45
315/3	315	320.5	3	3020	75	7	50	51
315/4	315	320.5	4	3020	75	6	65	51
315/5	315	320.5	5	3535	90	7	80	89
315/6	315	320.5	6	3535	90	6	95	89
SPA 355/1	355	360.5	1	2012	50	4	20	32
355/2	355	360.5	2	2517	60	4	35	45
355/3	355	360.5	3	3020	75	4	50	51
355/4	355	360.5	4	3020	75	5	65	51
355/5	355	360.5	5	3535	90	4	80	89
355/6	355	360.5	6	3535	90	5	95	89
SPA 400/1	400	400.5	1	2012	50	4	20	32
400/2	400	400.5	2	2517	60	4	35	45
400/3	400	400.5	3	3020	75	4	50	51
400/4	400	400.5	4	3020	75	5	65	51
400/5	400	400.5	5	3535	90	4	80	89
400/6	400	400.5	6	3535	90	5	95	89
SPA 450/1	450	455.5	1	2012	50	4	20	32
450/2	450	455.5	2	2517	60	4	35	45
450/3	450	455.5	3	3020	75	4	50	51
450/4	450	455.5	4	3020	75	5	65	51
450/5	450	455.5	5	3535	90	4	80	89
450/6	450	455.5	6	3535	90	5	95	89
SPA 500/1	500	505.5	1	2517	50	4	20	45
500/2	500	505.5	2	2517	60	4	35	45
500/3	500	505.5	3	3020	75	4	50	51
500/4	500	505.5	4	3020	75	5	65	51
500/5	500	505.5	5	3535	90	4	80	89
500/6	500	505.5	6	3535	90	5	95	89
SPA 560/2	560	565.5	2	3020	75	4	35	51
560/3	560	565.5	3	3020	75	4	50	51
560/4	560	565.5	4	3535	90	4	65	89
560/5	560	565.5	5	3535	90	4	80	89
560/6	560	565.5	6	3535	90	5	95	89

**KATALOGTA BULUNMAYAN ÖLÇÜLER İÇİN İMALAT İMKANIMIZ MEVCUTTUR**

# BURÇLU® KASNAK TIPLERİ

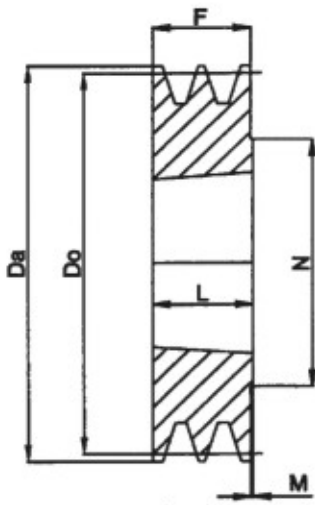

TİP 1

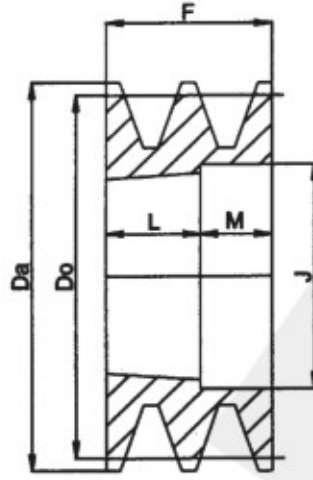

TİP 2

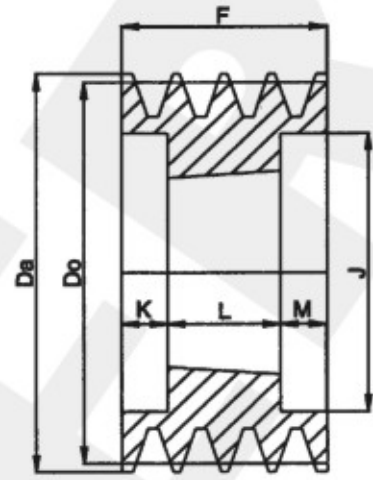

TİP 3

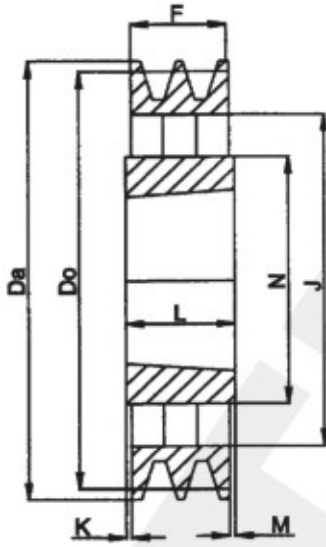

TİP 4

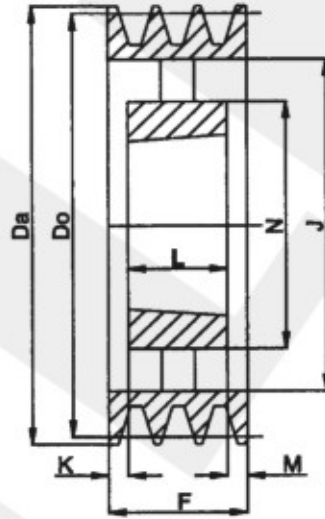

TİP 5

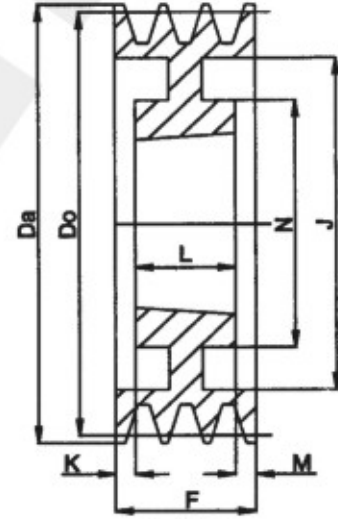

TİP 6

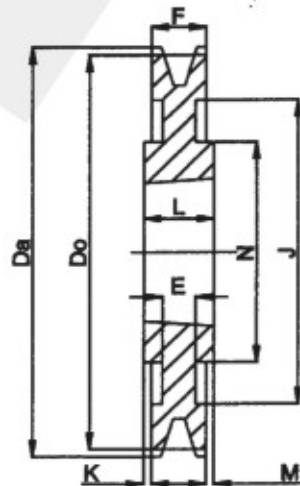

TİP 7



# BURÇLU® KASNAKLAR

## SPB (16,5 - 17)

Parça No	Anma Çapı Do	Dış Çapı Da	Kanal No	Burç No	Max. Delik	Kasnak Tipi	F	L
SPB 100/1	100	107	1	1610	42	1	25	25
100/2	100	107	2	1610	42	2	44	25
100/3	100	107	3	1610	42	2	63	25
SPB 112/1	112	119	1	1610	42	1	25	25
112/2	112	119	2	1610	42	2	44	25
112/3	112	119	3	1610	42	2	63	25
SPB 118/1	118	125	1	1610	42	1	25	25
118/2	118	125	2	1610	42	2	44	25
118/3	118	125	3	1610	42	2	63	25
SPB 125/1	125	132	1	1610	42	1	25	25
125/2	125	132	2	2012	50	2	44	32
125/3	125	132	3	2012	50	2	63	32
125/4	125	132	4	2012	50	3	82	32
125/5	125	132	5	2012	50	3	101	32
SPB 132/1	132	139	1	1610	42	1	25	25
132/2	132	139	2	2012	50	2	44	32
132/3	132	139	3	2012	50	2	63	32
132/4	132	139	4	2012	50	3	82	32
132/5	132	139	5	2517	60	3	101	45
SPB 140/1	140	147	1	1610	42	1	25	25
140/2	140	147	2	2012	50	2	44	32
140/3	140	147	3	2012	50	2	63	32
140/4	140	147	4	2517	60	3	82	45
140/5	140	147	5	2517	60	3	101	45
140/6	140	147	6	2517	60	3	120	45
SPB 150/1	150	157	1	1610	42	1	25	25
150/2	150	157	2	2012	50	2	44	32
150/3	150	157	3	2517	60	2	63	45
150/4	150	157	4	2517	60	3	82	45
150/5	150	157	5	2517	60	3	101	45
150/6	150	157	6	2517	60	3	120	45
SPB 160/1	160	167	1	1610	42	1	25	25
160/2	160	167	2	2012	50	2	44	32
160/3	160	167	3	2517	60	2	63	45
160/4	160	167	4	2517	60	3	82	45
160/5	160	167	5	2517	60	3	101	45
160/6	160	167	6	3020	75	3	120	51
160/8	160	167	8	3020	75	3	158	51
SPB 170/1	170	177	1	1610	42	1	25	25
170/2	170	177	2	2012	50	2	44	32
170/3	170	177	3	2517	60	2	63	45
170/4	170	177	4	2517	60	3	82	45
170/5	170	177	5	3020	75	3	101	51
170/6	170	177	6	3020	75	3	120	51
170/8	170	177	8	3020	75	3	158	76

**KATALOGTA BULUNMAYAN ÖLÇÜLER İÇİN İMALAT İMKANIMIZ MEVCUTTUR**





**SPB (16,5 - 17)**

Parça No	Anma Çapı Do	Dış Çapı Da	Kanal No	Burç No	Max. Delik	Kasnak Tipi	F	L
SPB 180/1	180	187	1	1610	42	6	25	25
180/2	180	187	2	2517	60	1	44	45
180/3	180	187	3	2517	60	2	63	45
180/4	180	187	4	2517	60	3	82	45
180/5	180	187	5	3020	75	3	101	51
180/6	180	187	6	3020	75	3	120	51
180/8	180	187	8	3020	75	3	158	76
SPB 190/1	190	197	1	2012	50	7	25	32
190/2	190	197	2	2517	60	1	44	45
190/3	190	197	3	2517	60	2	63	45
190/4	190	197	4	2517	60	3	82	45
190/5	190	197	5	3020	75	3	101	51
190/6	190	197	6	3020	75	3	120	51
190/8	190	197	8	3020	75	3	158	75
SPB 200/1	200	207	1	2012	50	7	25	32
200/2	200	207	2	2517	60	1	44	45
200/3	200	207	3	2517	60	6	63	45
200/4	200	207	4	3020	75	3	82	51
200/5	200	207	5	3020	75	3	101	51
200/6	200	207	6	3020	75	3	120	51
200/8	200	207	8	3535	90	3	158	89
SPB 212/1	212	219	1	2012	50	7	25	32
212/2	212	219	2	2517	60	1	44	45
212/3	212	219	3	2517	60	6	63	45
212/4	212	219	4	3020	75	3	82	51
212/5	212	219	5	3020	75	3	101	51
212/6	212	219	6	3020	75	3	120	89
212/8	212	219	8			3	158	89
SPB 224/1	224	231	1	2012	50	7	25	32
224/2	224	231	2	2517	60	7	44	45
224/3	224	231	3	2517	60	6	63	45
224/4	224	231	4	3020	75	3	82	51
224/5	224	231	5	3020	75	3	101	51
224/6	224	231	6	3535	90	3	120	89
224/8	224	231	8	3535	90	3	158	89
224/10	224	231	10	3535	90	3	196	89
SPB 236/1	236	243	1	2012	50	7	25	32
236/2	236	243	2	2517	60	7	44	45
236/3	236	243	3	2517	60	6	63	45
236/4	236	243	4	3020	75	3	82	51
236/5	236	243	5	3535	90	3	101	89
236/6	236	243	6	3535	90	3	120	89
236/8	236	243	8	3535	90	3	158	89
236/10	236	243	10	3535	90	3	196	89
SPB 250/1	250	257	1	2012	50	7	25	32
250/2	250	257	2	2517	60	7	44	45
250/3	250	257	3	3020	75	6	63	51
250/4	250	257	4	3020	75	6	82	51
250/5	250	257	5	3535	90	3	101	89
250/6	250	257	6	3535	90	3	120	89
250/8	250	257	8	3535	90	3	158	89
250/10	250	257	10	3535	90	3	196	89

**SPB (16,5 - 17)**

Parça No	Anma Çapı Do	Dış Çapı Da	Kanal No	Burç No	Max. Delik	Kasnak Tipi	F	L
SPA 280/1	280	287	1	2012	50	7	25	32
280/2	280	287	2	2517	60	7	44	45
280/3	280	287	3	3020	75	6	63	51
280/4	280	287	4	3020	75	6	82	51
280/5	280	287	5	3535	90	6	101	89
280/6	280	287	6	3535	90	6	120	89
280/8	280	287	8	3535	90	6	158	89
280/10	280	287	10	3535	90	6	196	89
SPB300/2	300	307	2	2517	60	7	44	45
300/3	300	307	3	3020	75	6	63	51
300/4	300	307	4	3020	75	6	82	51
300/5	300	307	5	3535	90	6	101	89
300/6	300	307	6	3535	90	6	120	89
300/8	300	307	8	3535	90	6	158	89
SPB315/1	315	322	1	2012	50	7	25	32
315/2	315	322	2	2517	60	7	44	45
315/3	315	322	3	3020	75	6	63	51
315/4	315	322	4	3535	90	7	82	89
315/5	315	322	5	3535	90	6	101	89
315/6	315	322	6	3535	90	6	120	89
315/8	315	322	8	3535	90	6	158	89
315/10	315	322	10	3535	90	6	196	89
SPB335/2	335	342	2	3020	75	7	44	45
335/3	335	342	3	3020	75	6	63	51
335/4	335	342	4	3535	90	7	82	89
335/5	335	342	5	3535	90	6	101	89
335/6	335	342	6	3535	90	6	120	89
335/8	335	342	8	3535	90	6	158	89
335/10	335	342	10	4040	100	6	196	102
SPB355/2	355	362	2	3020	75	4	44	51
355/3	355	362	3	3020	75	5	63	51
355/4	355	362	4	3535	90	7	82	89
355/5	355	362	5	3535	90	5	101	89
355/6	355	362	6	3535	90	6	120	89
355/8	355	362	8	3535	90	6	158	89
355/10	355	362	10	4040	100	6	196	102
SPB400/2	400	407	2	3020	75	4	44	51
400/3	400	407	3	3535	90	4	63	89
400/4	400	407	4	3535	90	4	82	89
400/5	400	407	5	3535	90	5	101	89
400/6	400	407	6	3535	90	5	120	89
400/8	400	407	8	4040	100	5	158	102
400/10	400	407	10	4040	100	5	196	102
SPB450/2	450	407	2	3020	75	4	44	51
450/3	450	407	3	3535	90	4	63	89
450/4	450	407	4	3535	90	4	82	89
450/5	450	407	5	3535	90	5	101	89
450/6	450	407	6	4040	100	5	120	102
450/8	450	407	8	4040	100	5	158	102
450/10	450	407	10	4040	100	5	196	114

**KATALOGTA BULUNMAYAN ÖLÇÜLER İÇİN İMALAT İMKANIMIZ MEVCUTTUR**

# BURÇLU® KASNAK TIPLERİ

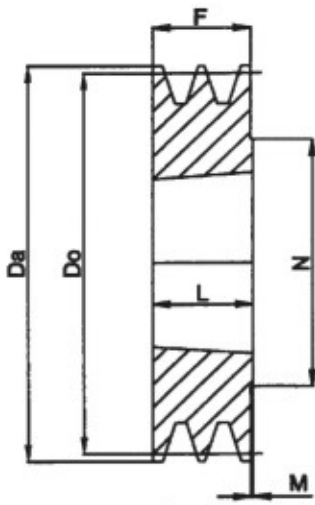

TİP 1

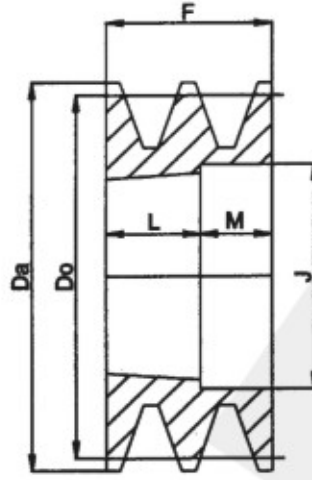

TİP 2

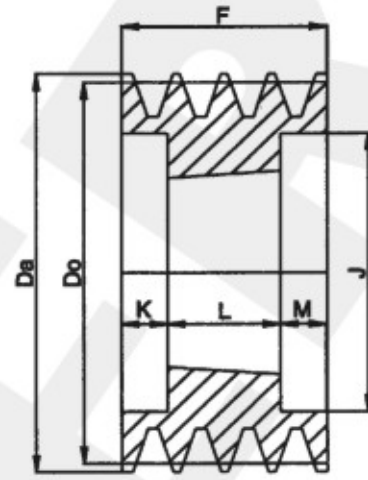

TİP 3

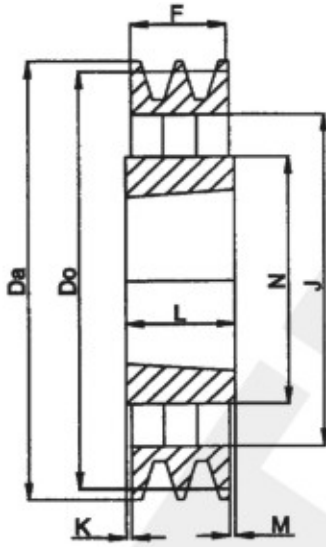

TİP 4

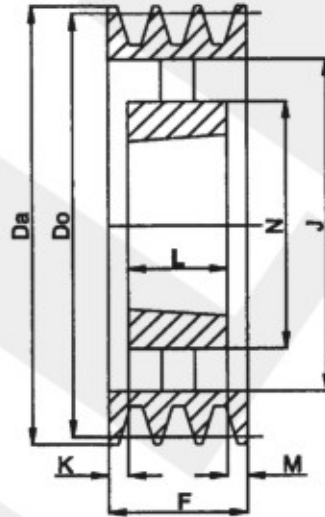

TİP 5

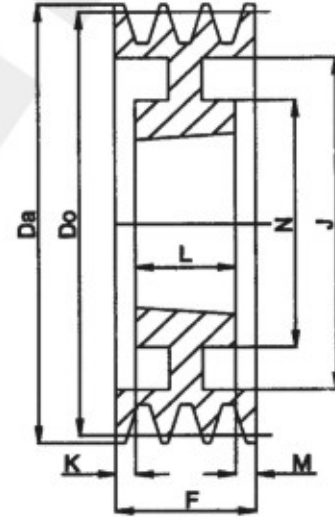

TİP 6

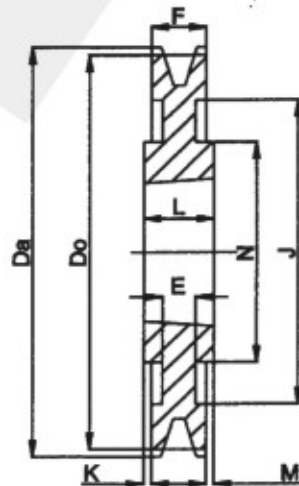

TİP 7



# BURÇLU® KASNAKLAR

## SPC (22)

Parça No	Anma Çapı Do	Dış Çapı Da	Kanal No	Burç No	Max. Delik	Kasnak Tipi	F	L
SPC 140/2	140	149.6	2	2012		2	60	30
140/3	140	149.6	3	2012		3	85	30
SPC 150/2	150	159.6	2	2012		2	60	30
150/3	150	159.6	3	2517		2	85	45
SPC 190/2	190	199.6	2	2517		2	60	45
190/3	190	199.6	3	2517		3	85	45
190/4	190	199.6	4	3020		4	111	51
190/5	190	199.6	5	3020		5	136	51
SPC 200/3	200	209.6	3	2517	60	3	85	45
200/4	200	209.6	4	3020	75	3	111	51
200/5	200	209.6	5	3535	90	3	136	89
200/6	200	209.6	6	3535	90	3	162	89
200/8	200	209.6	8	3535	90	3	213	89
SPC 212/3	212	221.6	3	3020	75	3	85	51
212/4	212	221.6	4	3020	75	3	111	51
212/5	212	221.6	5	3535	90	3	136	89
212/6	212	221.6	6	3535	90	3	162	89
212/8	212	221.6	8	3535	90	3	213	89
SPC 224/2	224	233.6	2	3020	75	3	60	51
224/3	224	233.6	3	3020	75	3	85	51
224/4	224	233.6	4	3535	90	3	111	89
224/5	224	233.6	5	3535	90	3	136	89
224/6	224	233.6	6	3535	90	3	162	89
224/8	224	233.6	8	3535	90	3	213	89
SPC 236/3	236	245.6	3	3020	75	3	85	51
236/4	236	245.6	4	3535	90	3	111	89
236/5	236	245.6	5	3535	90	3	136	89
236/6	236	245.6	6	3535	90	3	162	89
236/8	236	245.6	8	3535	90	3	213	89
SPC 250/2	250	259.6	2	3020	75	3	60	51
250/3	250	259.6	3	3020	75	3	85	51
250/4	250	259.6	4	3535	90	3	111	89
250/5	250	259.6	5	3535	90	3	136	89
250/6	250	259.6	6	3535	90	3	162	89
250/8	250	259.6	8	3535	90	3	213	89
250/10	250	259.6	10	4040,	100	3	264	102
SPC 265/3	265	274.6	3	3535	90	1	85	89
265/4	265	274.6	4	3535	90	3	111	89
265/5	265	274.6	5	3535	90	3	136	89
265/6	265	274.6	6	3535	90	3	162	89
265/8	265	274.6	8	3535	90	3	213	89
SPC 280/2	280	289.6	2	3020	75	5	60	51
280/3	280	289.6	3	3535	90	1	85	89
280/4	280	289.6	4	3535	90	3	111	89
280/5	280	289.6	5	3535	90	3	136	89
280/6	280	289.6	6	3535	90	3	162	89
280/8	280	289.6	8	3535	90	3	213	89
280/10	280	289.6	10	4040	100	3	264	102
SPC 300/2	300	309.6	2	3020	75	5	60	51
300/3	300	309.6	3	3535	90	7	85	89
300/4	300	309.6	4	3535	90	6	111	89
300/5	300	309.6	5	3535	90	6	136	89
300/6	300	309.6	6	3535	90	6	162	89
300/8	300	309.6	8	4040	100	3	213	102
300/10	300	309.6	10	4545	110	3	264	114

## SPC (22)

Parça No	Anma Çapı Do	Dış Çapı Da	Kanal No	Burç No	Max. Delik	Kasnak Tipi	F	L
SPC 315/3	315	324.6	3	3535	90	7	85	89
315/4	315	324.6	4	3535	90	6	111	89
315/5	315	324.6	5	3535	90	6	136	89
315/6	315	324.6	6	3535	90	6	162	89
315/8	315	324.6	8	4040	100	6	213	102
315/10	315	324.6	10	4545	110	3	264	114
SPC 335/2	335	344.6	2	3020	75	5	60	51
335/3	335	344.6	3	3535	90	7	85	89
335/4	335	344.6	4	3535	90	6	111	89
335/5	335	344.6	5	3535	90	6	136	89
335/6	335	344.6	6	3535	90	6	162	89
335/8	335	344.6	8	4040	100	6	213	102
SPC 355/3	355	364.6	3	3535	90	7	85	89
355/4	355	364.6	4	3535	90	6	111	89
355/5	355	364.6	5	3535	90	6	136	89
355/6	355	364.6	6	3535	90	6	162	89
355/8	355	364.6	8	4040	100	6	213	102
355/10	355	364.6	10	4545	110	6	264	114
SPC 375/3	375	384.6	3	3535	90	7	85	89
375/4	375	384.6	4	3535	90	6	111	89
375/5	375	384.6	5	3535	90	6	136	89
375/6	375	384.6	6	4040	100	6	162	102
375/8	375	384.6	8	4545	110	6	213	114
SPC 400/2	400	409.6	2	3020	75	5	60	51
400/3	400	409.6	3	3535	90	4	85	89
400/4	400	409.6	4	3535	90	5	111	89
400/5	400	409.6	5	3535	90	5	136	89
400/6	400	409.6	6	4040	100	6	162	102
400/8	400	409.6	8	4545	110	6	213	114
400/10	400	409.6	10	5050	125	6	264	127
SPC 425/3	425	434.6	3	3535	90	4	85	89
425/4	425	434.6	4	3535	90	5	111	89
425/5	425	434.6	5	4040	100	5	136	102
425/6	425	434.6	6	4545	110	6	162	114
425/8	425	434.6	8	5050	125	6	213	127
SPC 450/3	450	459.6	3	3535	90	4	85	89
450/4	450	459.6	4	3535	90	5	111	89
450/5	450	459.6	5	4040	100	5	136	102
450/6	450	459.6	6	4545	110	6	162	114
450/8	450	459.6	8	5050	125	6	213	127
450/10	450	459.6	10	5050	125	6	264	127
SPC 475/3	475	484.6	3	3535	90	4	85	89
475/4	475	484.6	4	3535	90	5	111	89
475/5	475	484.6	5	4040	100	5	136	102
475/6	475	484.6	6	4545	110	6	162	114
475/8	475	484.6	8	5050	125	6	213	127

**KATALOGTA BULUNMAYAN ÖLÇÜLER İÇİN İMALAT İMKANIMIZ MEVCUTTUR**

# BURÇLU® KASNAK TIPLERİ

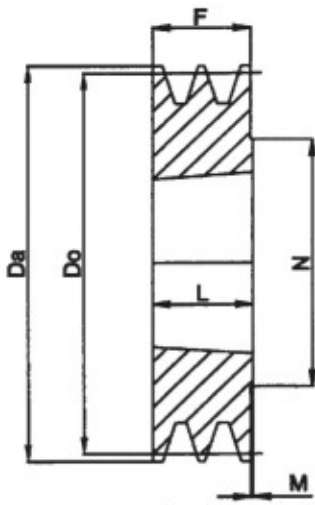

TİP 1

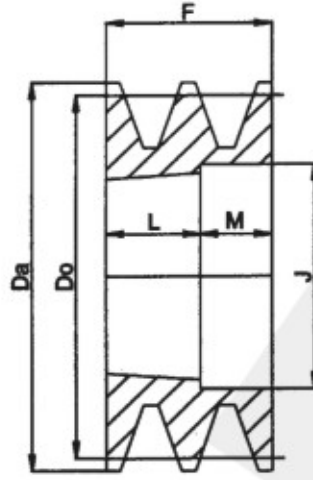

TİP 2

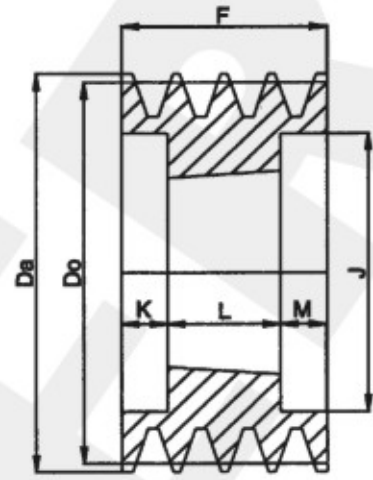

TİP 3

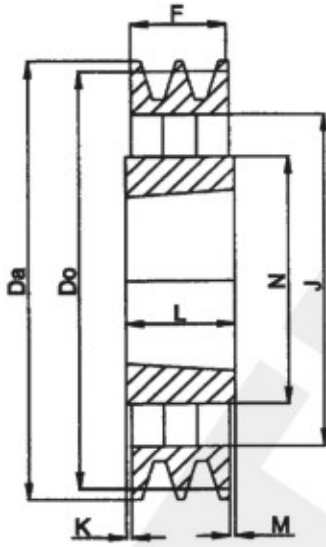

TİP 4

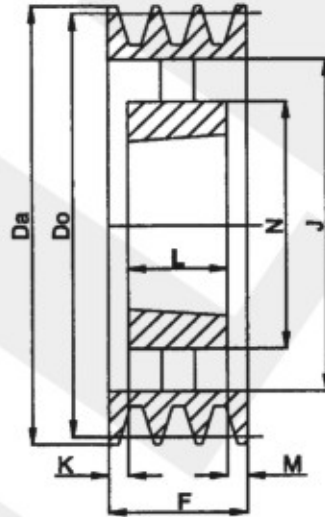

TİP 5

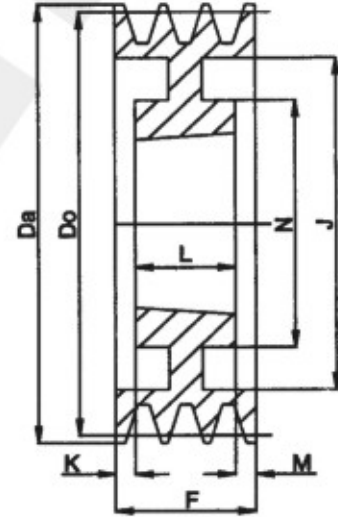

TİP 6

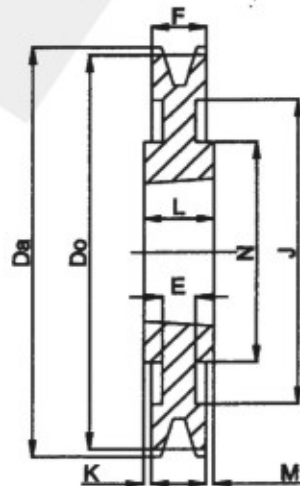

TİP 7

# BURÇLU® KASNAKLAR



## SPZ (9,5 - 10)

## SPZ (9,5 - 10)

Parça no:	Anma çapı:	Diş çapı:	Kanal no:	Burç no:	Max.delik	Kasnak tipi
SPZ 50/1	50	54	1	1008	25	1
50/	50	54	2	1008	25	2
SPZ 56/1	56	60	1	1008	25	2
56/2	56	60	2	1008	25	2
SPZ 60/1	60	64	1	1008	25	2
60/2	60	64	2	1008	25	2
SPZ 63/1	63	67	1	1108	28	1
63/2	63	67	2	1108	28	2
63/3	63	67	3	1108	28	2
SPZ 67/1	67	71	1	1108	28	1
67/2	67	71	2	1108	28	2
67/3	67	71	3	11,08	28	2
SPZ 71/1	71	75	1	1108	28	1
71/2	71	75	2	1108	28	2
71/3	71	75	3	1108	28	2
SPZ 75/1	75	79	1	1108	28	1
75/2	75	79	2	1210	32	2
75/3	75	79	3	1210	32	2
SPZ 80/1	80	84	1	1210	32	1
80/2	80	84	2	1210	32	2
80/3	80	84	3	1210	32	2
80/4	80	84	4	1210	32	2
SPZ 85/1	85	89	1	1210	32	1
85/2	85	89	2	1610	42	2
85/3	85	89	3	1610	42	2
85/4	85	89	4	1610	42	2
85/5	85	89	5	1610	42	2
SPZ 90/1	90	94	1	1210	32	1
90/2	90	94	2	1610	42	2
90/3	90	94	3	1610	42	2
90/4	90	94	4	1610	42	2
90/5	90	94	5	1610	42	2
90/6	90	94	6	1610	42	2
SPZ 95/1	95	99	1	1210	32	1
95/2	95	99	2	1610	42	2
95/3	95	99	3	1610	42	2
95/4	95	99	4	1610	42	2
95/5	95	99	5	1610	42	2
95/6	95	99	6	1610	42	2
SPZ 100/1	100	104	1	1210	42	1
100/2	100	104	2	1610	42	2
100/3	100	104	3	1610	42	2
100/4	100	104	4	1610	42	2
100/5	100	104	5	2012	50	2
100/6	100	10,4	6	2012	50	2
SPZ 106/1	106	110	1	1610	42	1
106/2	106	110	2	1610	42	2
106/3	106	110	3	1610	42	2
106/4	106	110	4	1610	42	2
106/5	106	110	5	2012	50	2
106/6	106	110	6	2012	50	2
SPZ 112/1	112	116	1	1610	42	1
112/2	112	116	2	1610	42	2
112/3	112	116	3	2012	50	2
112/4	112	116	4	2012	50	2
112/5	112	116	5	2012	50	2
112/6	112	116	6	2012	50	2
SPZ 118/1	118	122	1	1610	42	1
118/2	118	122	2	1610	42	2
118/3	118	122	3	2012	50	2
118/4	118	122	4	2012	50	2
118/5	118	122	5	2012	50	2
118/6	118	122	6	2012	50	2
SPZ 125/1	125	129	1	1610	42	1
125/2	125	129	2	1610	42	2
125/3	125	129	3	2012	50	2
125/4	125	129	4	2012	50	2
125/5	125	129	5	2012	50	2
125/6	125	129	6	2517	50	2
132/1	132	136	1	1610	42	1
132/2	132	136	2	1610	42	2
132/3	132	136	3	2012	50	2
132/4	132	136	4	2012	50	2
132/5	132	136	5	2517	50	2
132/6	132	136	6	2517	50	2

Parça no:	Anma çapı:	Diş çapı:	Kanal no:	Burç no:	Max.delik	Kasnak tipi
SPZ 140/3	140	144	1	144	42	1
140/2	140	144	2	2012	42	2
140/3	140	144	3	2012	50	2
140/4	140	144	4	2517	50	2
140/5	140	144	5	2517	60	2
140/6	140	144	6	2517	60	2
140/8	140	144	8	2517	60	3
SPZ 150/1	150	154	1	1610	42	1
150/2	150	154	2	2012	50	1
150/3	150	154	3	2012	50	2
150/4	150	154	4	2517	60	2
150/5	150	154	5	2517	60	2
150/6	150	154	6	2517	60	2
150/8	150	154	8	2517	60	3
SPZ 160/1	160	164	1	1610	42	1
160/2	160	164	2	2012	50	1
160/3	160	164	3	2012	50	2
160/4	160	164	4	2517	60	2
160/5	160	164	5	2517	60	2
160/6	160	164	6	2517	60	2
160/8	160	164	8	2517	60	3
SPZ 170/1	170	174	1	1610	42	1
170/2	170	174	2	2012	50	1
170/3	170	174	3	2012	50	2
170/4	170	174	4	2517	60	2
170/5	170	174	5	2517	60	2
170/6	170	174	6	2517	60	2
SPZ 180/1	180	184	1	1610	42	1
180/2	180	184	2	2012	50	1
180/3	180	184	3	2012	50	2
180/4	180	184	4	2517	60	2
180/5	180	184	5	2517	60	2
180/6	180	184	6	2517	60	2
180/8	180	184	8	2517	60	3
SPZ 190/1	190	194	1	1610	42	1
190/2	190	194	2	2012	50	1
190/3	190	194	3	2012	50	6
190/4	190	194	4	2517	60	6
190/5	190	194	5	2517	60	6
190/6	190	194	6	2517	60	6
SPZ 200/1	200	204	1	2012	50	7
200/2	200	204	2	2012	50	7
200/3	200	204	3	2012	50	6
200/4	200	204	4	2517	60	6
200/5	200	204	5	2517	60	6
200/6	200	204	6	2517	60	6
200/8	200	204	8	3020	75	3
SPZ 224/1	224	228	1	2012	50	4
224/2	224	228	2	2012	50	4
224/3	224	228	3	2012	50	5
224/4	224	228	4	2517	60	5
224/5	224	228	5	2517	60	5
224/6	224	228	6	2517	60	5
224/8	2,24	228	8	3020	75	6
SPZ 250/1	250	254	1	2012	50	4
250/2	250	254	2	2012	50	4
250/3	250	254	3	2012	50	5
250/4	250	254	4	2517	60	5
250/5	250	254	5	2517	60	5
250/6	250	254	6	2517	60	5
250/8	250	254	8	3020	75	6
SPZ 280/1	280	284	1	2012	50	4
280/2	280	284	2	2012	50	4
280/3	280	284	3	2517	60	5
280/4	280	284	4	2517	60	5
280/5	280	284	5	2517	60	5
280/6	280	284	6	2517	60	5
280/8	280	284	8	3020	75	6
SPZ 315/1	315	319	1	2012	50	4
315/2	315	319	2	2012	50	4
315/3	315	319	3	2517	60	4
315/4	315	319	4	2517	60	5
315/5	315	319	5	2517	60	5
315/6	315	319	6	2517	60	5
SPZ 355/1	355	359	1	2012	50	4
355/2	355	359	2	2012	50	4
355/3	355	359	3	2715	60	4
355/4	355	359	4	2715	60	5
355/5	355	359	5	2715	60	5
355/6	355	359	6	2715	60	5
355/8	355	359	8	33030	75	5
SPZ 400/1	400	404	1	2012	50	4
400/2	400	404	2	2517	60	4
400/3	400	404	3	2517	60	4
400/4	400	404	4	2517	60	5
400/5	400	404	5	3020	75	5
400/6	400	404	6	3030	75	5
400/8	400	404	8	3030	75	5
SPZ 450/1	450	454	1	2517	60	4
450/2	450	454	2	2517	60	4
450/3	450	454	3	2517	60	4
450/4	450	454	4	3020	75	5
450/5	450	454	5	3020	75	5
450/6	450	454	6	3030	75	5
450/8	450	454	8	3535	90	5

**KATALOGTA BULUNMAYAN ÖLÇÜLER İÇİN İMALAT İMKANIMIZ MEVCUTTUR**