

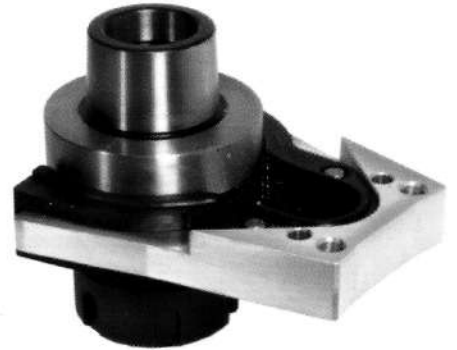

HSK 63F - ISO 30 KAFA TUTUCU VE ÇATAL

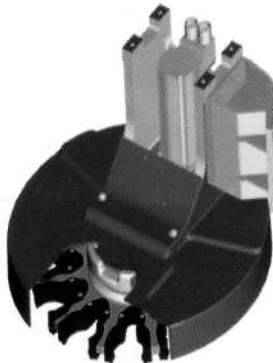
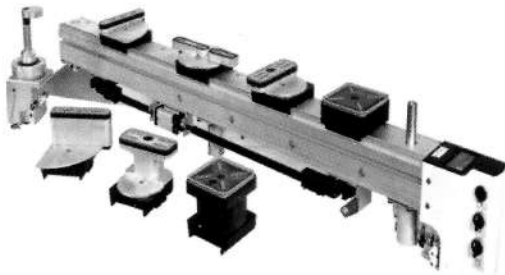

ATLIER

Rulmanlık Endüstriyel Ekipman Tic. ve San. Ltd. řti.

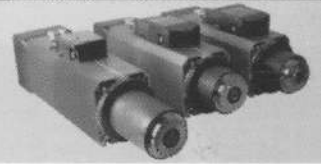

5 EKSEN KAFA SPİNDLE MOTORLARI

QS-2 7,5/12 24 63F

Güç:7,5Kw / 9,5Kw - S1 / S6

HSK F63

4 Kutuplu 380 V

Rulman:Seramik Bilyalı

Maksimum Devir: 24000 rpm

Soğutma:Sıvı



QX-2 8,5/12 24 63F NC

Güç:8,5Kw / 10Kw - S1 / S6

HSK F63

4 Kutuplu 380 V

Rulman:Seramik Bilyalı

Maksimum Devir: 24000 rpm

Soğutma:Sıvı

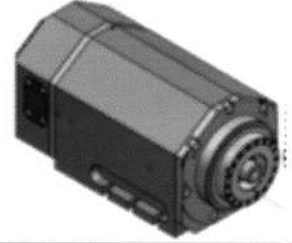

QS-2 10/12 24 63F

Güç:10Kw / 12Kw - S1 / S6

HSK F63

4 Kutuplu 380 V

Rulman:Seramik Bilyalı

Maksimum Devir: 24000 rpm

Soğutma:Sıvı

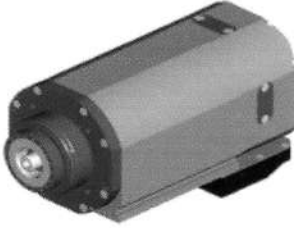

QS-2 15/12 24 63F

Güç:15Kw / 17Kw - S1 / S6

HSK F63

4 Kutuplu 380 V

Rulman:Seramik Bilyalı

Maksimum Devir: 24000 rpm

Soğutma:Sıvı



5 EKSEN KAFALAR

KQS75

Güç:7,5Kw / 9,5Kw - S1 / S6

HSK F63

4 Kutuplu 380 V

Rulman:Seramik Bilyalı

Maksimum Devir: 24000 rpm

Soğutma:Sıvı



KQS100

Güç:10Kw / 12Kw - S1 / S6

HSK F63

4 Kutuplu 380 V

Rulman:Seramik Bilyalı

Maksimum Devir: 24000 rpm

Soğutma:Sıvı



C AKS



KISA BURUN

UZUN BURUN

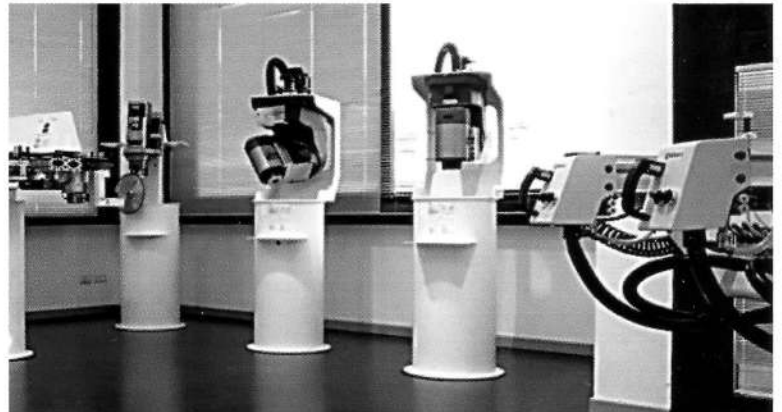

ATLIER

Rulmanlık Endüstriyel Ekipman Tic. ve San. Ltd. Şti.

AC Servo Motor Sistemleri



200W

AC Servo Motor 3000rpm 0,63 Nm
AC Servo Sürücü 220 VAC
5 Metre motor kablosu
5 Metre encoder kablosu



400W

AC Servo Motor 3000rpm 1,27 Nm
AC Servo Sürücü 220 VAC
5 Metre motor kablosu
5 Metre encoder kablosu

400W

AC Servo Motor Frenli
AC Servo Sürücü
5 Metre motor kablosu
5 Metre encoder kablosu

750W

AC Servo Motor 3000rpm 2,40 Nm
AC Servo Sürücü 220 VAC
5 Metre motor kablosu
5 Metre encoder kablosu

750W

AC Servo Motor Frenli
AC Servo Sürücü
5 Metre motor kablosu
5 Metre encoder kablosu

1 KW

AC Servo Motor 2000rpm 4,77 Nm
AC Servo Sürücü 220 VAC
5 Metre motor kablosu
5 Metre encoder kablosu

1 KW

AC Servo Motor Frenli
AC Servo Sürücü
5 Metre motor kablosu
5 Metre encoder kablosu

1,5 KW

AC Servo Motor 2000rpm 7,16 Nm
AC Servo Sürücü 220 VAC
5 Metre motor kablosu
5 Metre encoder kablosu

1,5 KW

AC Servo Motor Frenli
AC Servo Sürücü
5 Metre motor kablosu
5 Metre encoder kablosu

2 KW

AC Servo Motor 2000rpm 9,55 Nm
AC Servo Sürücü 220 VAC
5 Metre motor kablosu
5 Metre encoder kablosu

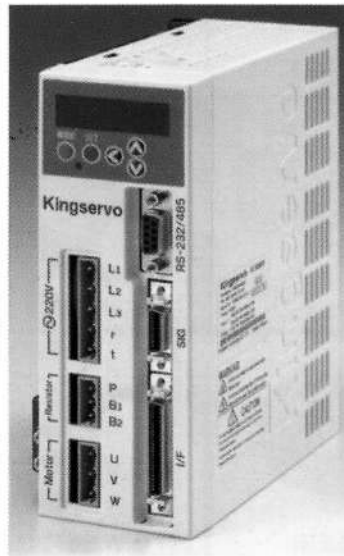
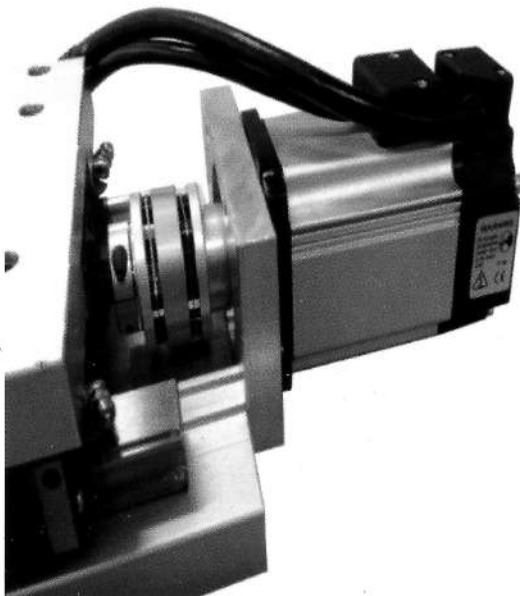
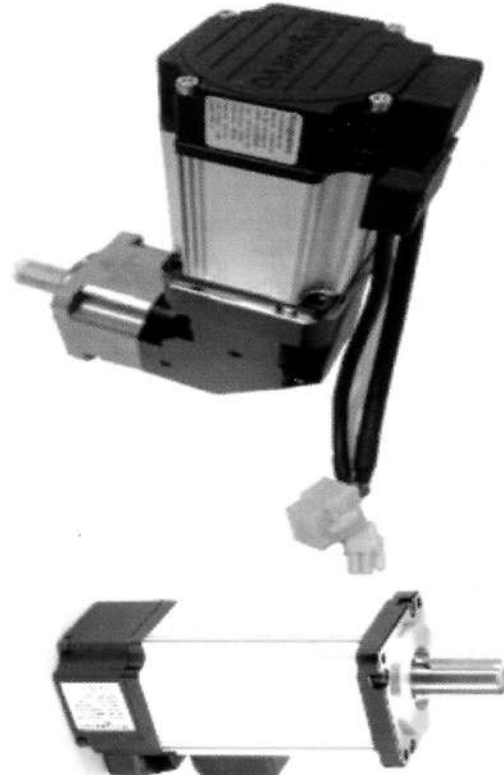

ATLIER

Rulmanlık Endüstriyel Ekipman Tic. ve San. Ltd. Şti.

AGGREGALAR

TWIN ER32 ER25B-H100

KOD : 29L0082089A

HSK F63

Çift Çıkış:ER32 - ER25

Maks.Spindle Hızı:10850rpm

Hız Oranı:1/1,43



TWIN ER32 ER25B-H100

KOD : 29L0171007E

ISO30

ER32 - ER25

Maks.Spindle Hızı:10850rpm

Hız Oranı:1/1,43



FOUR ER25-H100

KOD : 29L0082105E

HSK F63 - ISO30

Dört Çıkış: 4 X ER25

Maks.Spindle Hızı:10850rpm

Hız Oranı:1/1,43



FAST LINE Tilt ER25 H115

KOD : 29L0082101F

HSK F63 - ISO30

Ayarlanabilir Model: ER 25

Maks.Spindle Hızı:15500rpm

Hız Oranı:1/1



FAST ONE ER32-H100

HSK F63 - ISO30

Tek Çıkış:ER32

Maks.Spindle Hızı:15500rpm

Hız Oranı:1/1,07



TWIN PRO ER25 H162

HSK F63 - ISO30

Çift Çıkış:ER25

Maks.Spindle Hızı:6420rpm

Hız Oranı:1/2,65



MASTER D-SIDE H195

HSK F63 - ISO 30

Tek Çıkış:ER20

Maks.Spindle Hızı:13000rpm

Hız Oranı:1/1



MASTER COPY ER32 H175

HSK F63 - ISO 30

Tek Çıkış:ER32

Maks.Spindle Hızı:18000rpm

Hız Oranı:1/1



ONE ER32 H100



ONE BLADE H100



TWIN ER32 ER25 H100



TWIN PRO ER25 H162



TILT ER25 H115



FOUR ER25 H100



HBORE



WAVE



VBORE



DSIDE



TWIN M ER32



ONE M BLADE



TILT M



SOLID



MOULD



COPY

Agrega Bağlantı Flanşı (KOD : 29L0151358E)
Kısa Burun Spindle Motor İçin



Agrega Bağlantı Flanşı (KOD : 29L0186615C)
Uzun Burun Spindle Motor İçin



ATLIER

Rulmanlık Endüstriyel Ekipman Tic. ve San. Ltd. Şti.

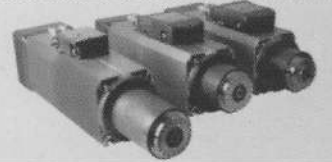
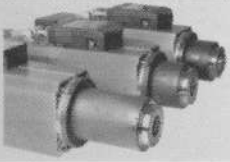

OTOMATİK TAKIM DEĞİŞTİRMELİ SPINDLE MOTORLAR (AĞAÇ İŞLEME)

Powertech 200QD-1F 4/12 24 I30 NC-CB

Güç:4Kw / 4,5Kw - S1 / S6

ISO 30

4 Kutuplu 380 V

Ön ve Arkada:

Alman Malı Seramik Rulman

Maksimum Devir: 24000 rpm

Soğutma:Elektrik Fanlı



Powertech 300QE-1F 8/12 24 I30 NC-CB

Güç:8Kw / 9,5Kw - S1 / S6

ISO 30

4 Kutuplu 380 V

Ön ve Arkada:

Alman Malı Seramik Rulman

Maksimum Devir: 24000 rpm

Soğutma:Elektrik Fanlı



Powertech 300QE-1F 8/12 24 I30 NL-CB

Güç:8Kw / 9,5Kw - S1 / S6

ISO 30 Uzun Burun

4 Kutuplu 380 V

Ön ve Arkada:

Alman Malı Seramik Rulman

Maksimum Devir: 24000 rpm

Soğutma:Elektrik Fanlı



Powertech 300QE-1F 8/12 24 63F NC-CB

Güç:8Kw / 9,5Kw - S1 / S6

HSK F63 Kısa Burun

4 Kutuplu 380 V

Ön ve Arkada:

Alman Malı Seramik Rulman

Maksimum Devir: 24000 rpm

Soğutma:Elektrik Fanlı



Powertech 400QE-1F 8,5/12 24 63F NL

Güç:8,5Kw / 11Kw - S1 / S6

HSK F63 Uzun Burun

4 Kutuplu 380 V

Ön ve Arkada:

Alman Malı Seramik Rulman

Maksimum Devir: 24000 rpm

Soğutma:Elektrik Fanlı



Powertech 400QE-1F 8,5/12 24 63F NC-CB

Güç:8,5Kw / 11Kw - S1 / S6

HSK F63 Kısa Burun

4 Kutuplu 380 V

Ön ve Arkada:

Alman Malı Seramik Rulman

Maksimum Devir: 24000 rpm

Soğutma:Elektrik Fanlı



Powertech 400QE-1F 10/11 24 63F NC

Güç:10Kw / 12Kw - S1 / S6

HSK F63 Kısa Burun

4 Kutuplu 380 V

Ön ve Arkada:

Alman Malı Seramik Rulman

Maksimum Devir: 24000 rpm

Soğutma:Elektrik Fanlı



Powertech 400QE-1F 10/11 24 63F NL

Güç:10Kw / 12Kw - S1 / S6

HSK F63 Uzun Burun

4 Kutuplu 380 V

Ön ve Arkada:

Alman Malı Seramik Rulman

Maksimum Devir: 24000 rpm

Soğutma:Elektrik Fanlı



Powertech 400QE-2 13/12 24 63F NL

Güç:13Kw / 15Kw - S1 / S6

HSK F63 Uzun Burun

4 Kutuplu 380 V

Ön ve Arkada:

Alman Malı Seramik Rulman

Maksimum Devir: 24000 rpm

Soğutma:Sıvı Soğutmalı



ISO 30 - HSK F63 Takım Tutucu



HSK F63 - ISO30 Çatal



ATLIER

Rulmanlık Endüstriyel Ekipman Tic. ve San. Ltd. Şti.



MANUEL TAKIM DEĞİŞTİRMELİ SPİNDLE MOTORLAR

MODEL:QN1 4,5/18 18 ER32 DX

KOD : 29L0178818D

Güç: 4,5Kw , V:380V

Bağlantı : ER32

Maks. Devir 18000

Dönüş Yönü : Saat Yönü



MODEL:QN-1F 4.5/18 24 ER32 DX

KOD:QN.200.A01.00

Güç: 4.5Kw , V:380V

Bağlantı : ER32

Maks. Devir : 24000 (Seramik Rulmanlı)

Dönüş Yönü : Saat Yönü



MODEL:QN1 6/18 18 ER32 DX

KOD : 29L0190883F

Güç: 6Kw , V:380V

Bağlantı : ER32

Maks. Devir 18000

Dönüş Yönü : Saat Yönü



MODEL:QN1 6/18 24 ER32 DX

KOD : 29L0178818D

Güç: 6Kw , V:380V

Bağlantı : ER32

Maks. Devir : 24000 (Seramik Rulmanlı)

Dönüş Yönü : Saat Yönü



ELEKTRİKLİ HARİCİ FAN SOĞUTMALI MODELLER

MODEL:QN-1F 4,5/18 18 ER32 DX

Güç: 4,5Kw , V:380V

Bağlantı : ER32

Maks. Devir : 18000

Dönüş Yönü : Saat Yönü



MODEL:QN-1F 4,5/18 24 ER32 DX

Güç: 4,5Kw , V:380V

Bağlantı : ER32

Maks. Devir : 24000 (Seramik Rulmanlı)

Dönüş Yönü : Saat Yönü



MODEL:QN-1F 6/18 18 ER32 DX

Güç: 6Kw , V:380V

Bağlantı : ER32

Maks. Devir : 18000

Dönüş Yönü : Saat Yönü



MODEL:QN-1F 6/18 24 ER32 DX

Güç: 6Kw , V:380V

Bağlantı : ER32

Maks. Devir : 24000 (Seramik Rulmanlı)

Dönüş Yönü : Saat Yönü



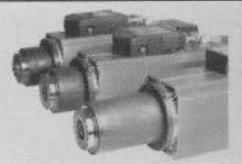
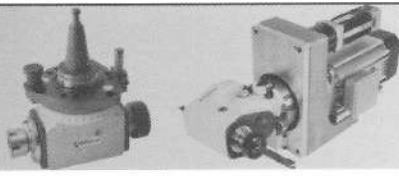

ÇOKLU DELİK DELME ÜNİTELERİ

F7.0H.00

7 Dikey Delme

Strok:60mm

Devir:4237rpm

Motor Gücü:2,2Kw

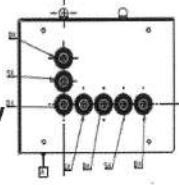

F11B.4H.00

7 Dikey + 4 Yatay + 1 Kesme

Strok:60mm

Dikey Devir:4150rpm

Yatay Devir:4150rpm

Kesme Devir:5300rpm

Motor Gücü:2,2Kw

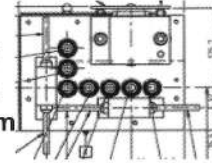

F12.0H.00

12 Dikey Delme

Strok:60mm

Devir:4237rpm

Motor Gücü:2,2Kw

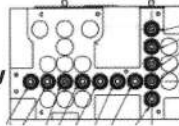

F14B.6H.00

8 Dikey + 6 Yatay + 1 Kesme

Strok:60mm

Dikey Devir:4237rpm

Yatay Devir:4237rpm

Kesme Devir:5380rpm

Motor Gücü:2,2Kw

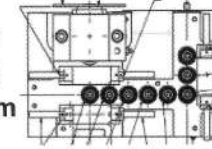

F18.0H.00

18 Dikey Delme

Strok:60mm

Devir:4237rpm

Motor Gücü:2,2Kw

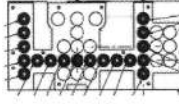

F18B.6H.00

12 Dikey + 6 Yatay + 1 Kesme

Strok:60mm

Dikey Devir:4237rpm

Yatay Devir:4237rpm

Kesme Devir:5380rpm

Motor Gücü:2,2Kw

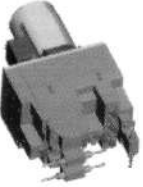
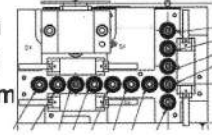

F26B.8H.00

18 Dikey + 8 Yatay + 1 Kesme

Strok:60mm

Dikey Devir:4237rpm

Yatay Devir:4237rpm

Kesme Devir:5380rpm

Motor Gücü:2,2Kw

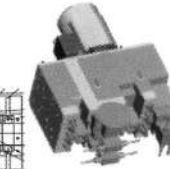
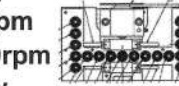

F14B.4H.00

10 Dikey + 4 Yatay + 1 Kesme

Strok:60mm

Dikey Devir:4230rpm

Yatay Devir:4230rpm

Kesme Devir:4230rpm

Motor Gücü:2,2Kw

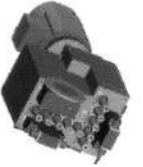
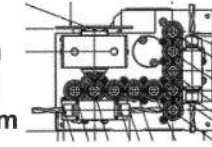

F16.6H.00

10 Dikey + 6 Yatay

Strok:60mm

Devir:4230rpm

Yatay Devir:4230rpm

Motor Gücü:2,2Kw

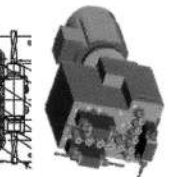
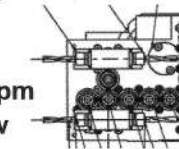

F22B.8H.00

14 Dikey + 8 Yatay + 1 Kesme

Strok:60mm

Dikey Devir:4230rpm

Yatay Devir:4230rpm

Kesme Devir:4230rpm

Motor Gücü:3Kw

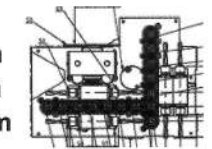

F22B2.8H.00

14 Dikey + 8 Yatay + 1 Kesme 0-90°

Strok:60mm

Dikey Devir:4230rpm

Yatay Devir:4230rpm

Kesme Devir:3530rpm

Motor Gücü:3Kw

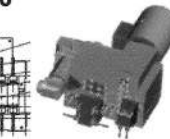
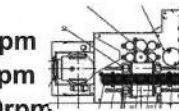

F26B2.12H.00

14 Dikey + 12 Yatay + 1 Kesme 0-90°

Strok:60mm

Dikey Devir:4230rpm

Yatay Devir:4230rpm

Kesme Devir:3530rpm

Motor Gücü:3Kw

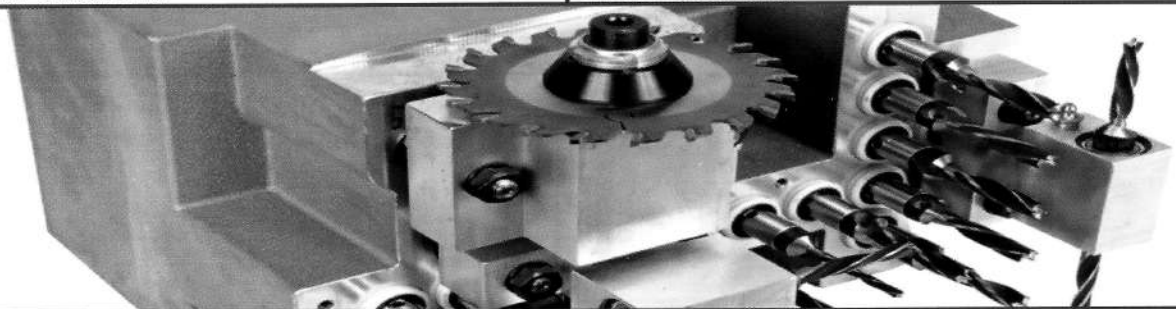
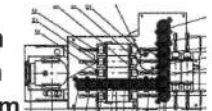

ATLIER

Rulmanlık Endüstriyel Ekipman Tic. ve San. Ltd. Şti.