

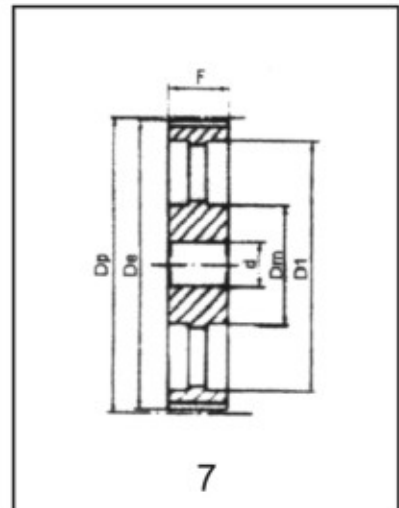

PLOT TİP TRİGER DİŞLİLER

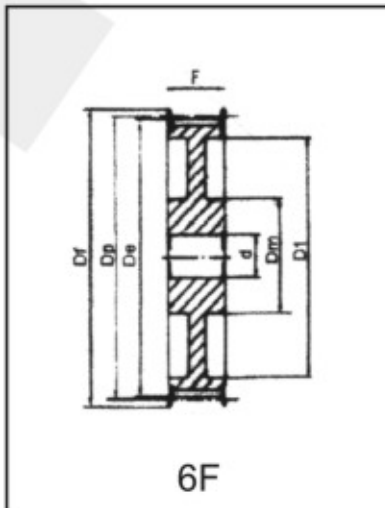

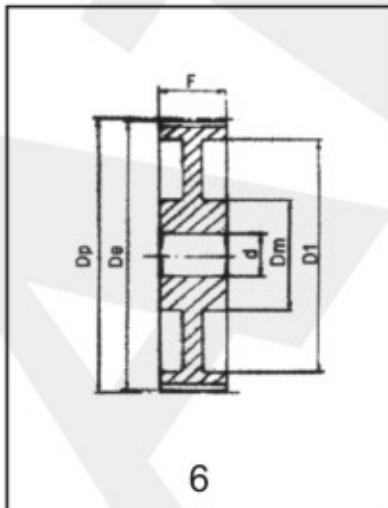
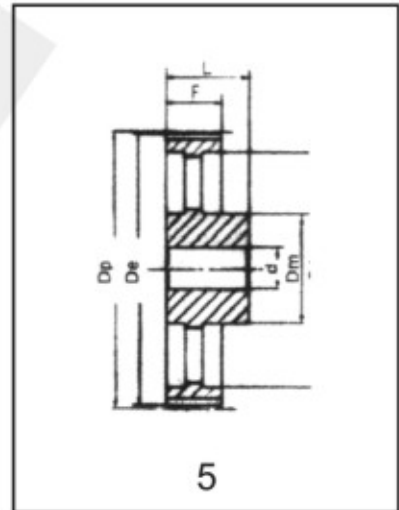
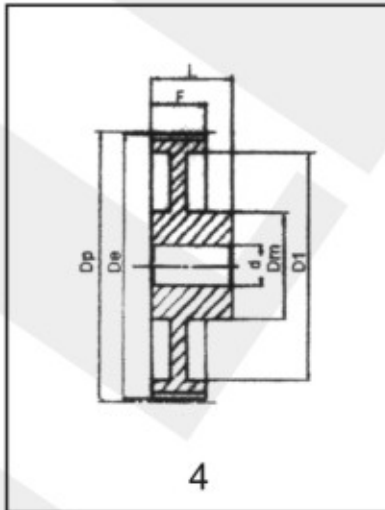
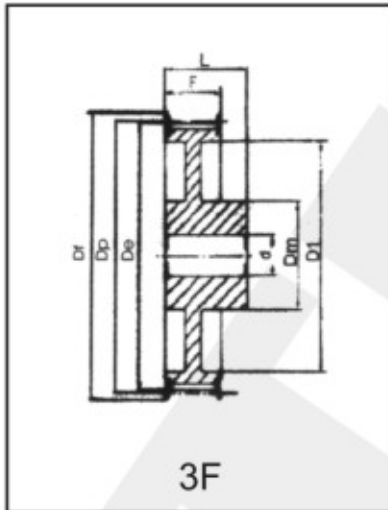
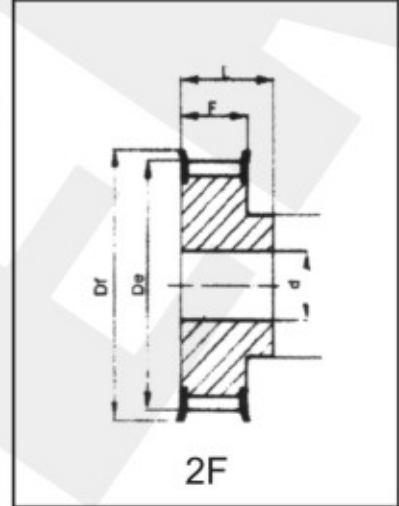
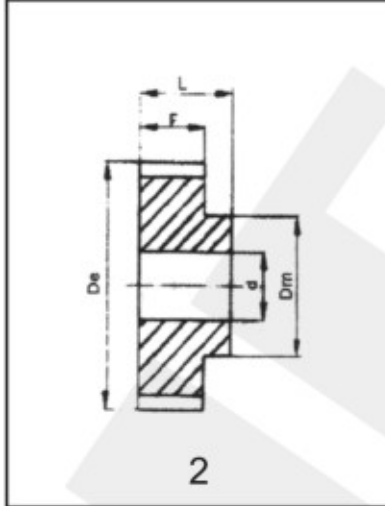
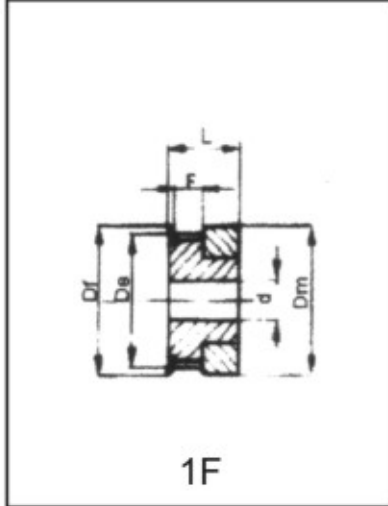

PLOT DELİKLİ TRİGER DİŞLİLER

T5 ---- AT5 ADIMLI TRİGER DİŞLİLER

T 5 B 10						
KOD CODE	TİP TYPE	d	Z	DP	F	L
10- T5- B10F	2F	6	10	15.92	15	22
12- T5- B10F	2F	6	12	19.10	15	22
14- T5- B10F	2F	6	14	22.28	15	22
16- T5- B10F	2F	6	16	25.47	15	22
18- T5- B10F	2F	6	18	28.65	15	22
20- T5- B10F	2F	6	20	31.83	15	22
22- T5- B10F	2F	6	22	35.02	15	22
24- T5- B10F	2F	6	24	38.20	15	22
26- T5- B10F	2F	8	26	41.38	15	22
28- T5- B10F	2F	8	28	44.56	15	22
30- T5- B10F	2F	8	30	47.75	15	22
32- T5- B10F	2F	8	32	50.93	15	22
36- T5- B10F	2F	8	36	57.30	15	22
40- T5- B10F	2F	8	40	63.66	15	22
44- T5- B10	2	8	44	70.03	15	22
48- T5- B10	2	8	48	76.40	15	22
56- T5- B10	2	8	56	89.13	15	22
64- T5- B10	2	10	64	101.86	15	22
72- T5- B10	2	10	72	114.59	15	22

T 5 B 16						
KOD CODE	TİP TYPE	d	Z	DP	F	L
10- T5- B16F	2F	6	10	15.92	21	27
12- T5- B16F	2F	6	12	19.10	21	27
14- T5- B16F	2F	6	14	22.28	21	27
16- T5- B16F	2F	6	16	25.47	21	27
18- T5- B16F	2F	6	18	28.65	21	27
20- T5- B16F	2F	6	20	31.83	21	27
22- T5- B16F	2F	6	22	35.02	21	27
24- T5- B16F	2F	6	24	38.20	21	27
26- T5- B16F	2F	8	26	41.38	21	27
28- T5- B16F	2F	8	28	44.56	21	27
30- T5- B16F	2F	8	30	47.75	21	27
32- T5- B16F	2F	8	32	50.93	21	27
36- T5- B16F	2F	8	36	57.30	21	27
40- T5- B16F	2F	8	40	63.66	21	27
44- T5- B16	2	8	44	70.03	21	27
48- T5- B16	2	8	48	76.40	21	27
56- T5- B16	2	8	56	89.13	21	27
64- T5- B16	2	10	64	101.86	21	27
72- T5- B16	2	10	72	114.59	21	27

T 5 B 25						
KOD CODE	TİP TYPE	d	Z	DP	F	L
10- T5- B25F	2F	6	10	15.92	30	36
12- T5- B25F	2F	6	12	19.10	30	36
14- T5- B25F	2F	6	14	22.28	30	36
16- T5- B25F	2F	6	16	25.47	30	36
18- T5- B25F	2F	6	18	28.65	30	36
20- T5- B25F	2F	6	20	31.83	30	36
22- T5- B25F	2F	6	22	35.02	30	36
24- T5- B25F	2F	6	24	38.20	30	36
26- T5- B25F	2F	8	26	41.38	30	36
28- T5- B25F	2F	8	28	44.56	30	36
30- T5- B25F	2F	8	30	47.75	30	36
32- T5- B25F	2F	8	32	50.93	30	36
36- T5- B25F	2F	8	36	57.30	30	36
40- T5- B25F	2F	8	40	63.66	30	36
44- T5- B25	2	8	44	70.03	30	36
48- T5- B25	2	8	48	76.40	30	36
56- T5- B25	2	8	56	89.13	30	36
64- T5- B25	2	10	64	101.86	30	36
72- T5- B25	2	10	72	114.59	30	36



PLOT TİP TRİGER DİŞLİLER

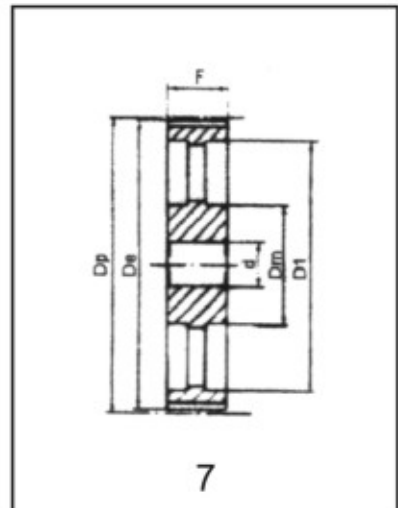
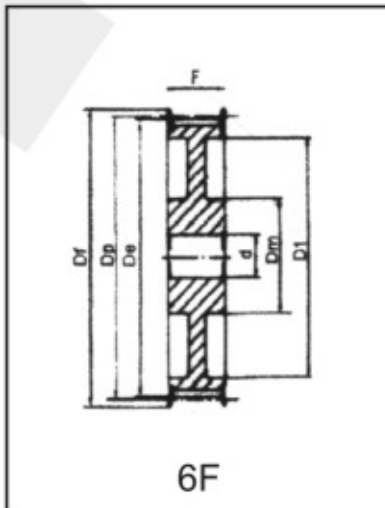
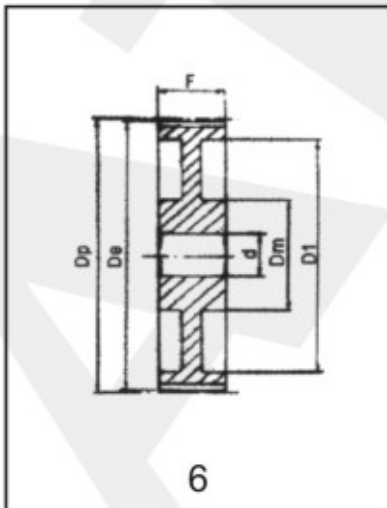
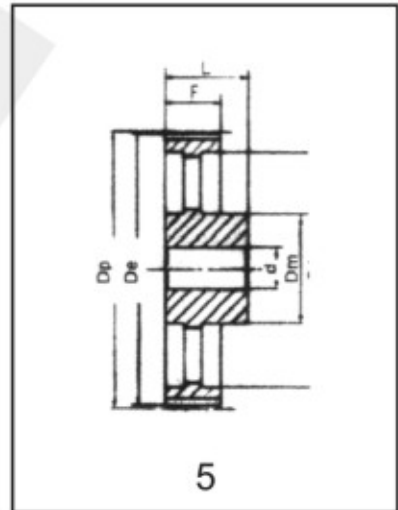
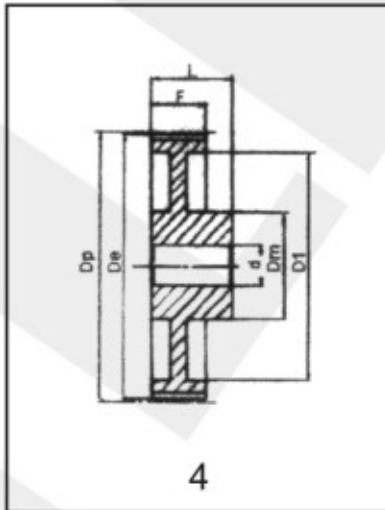
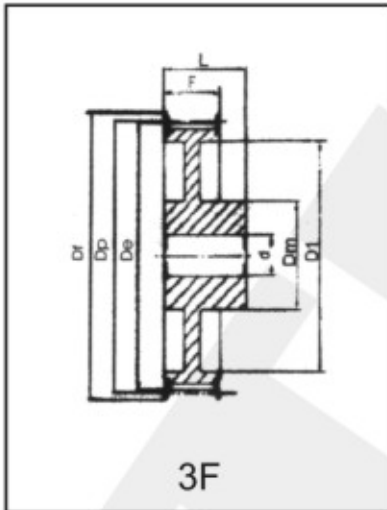
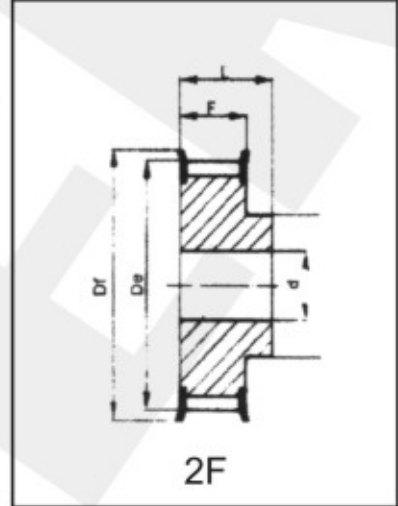
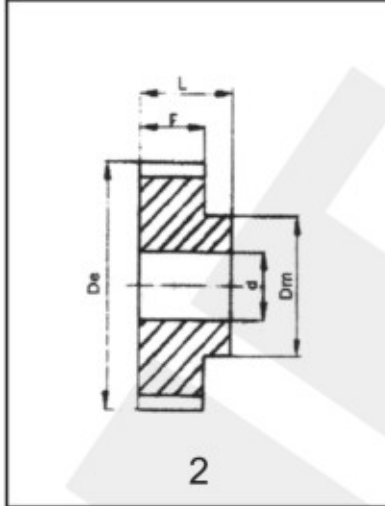
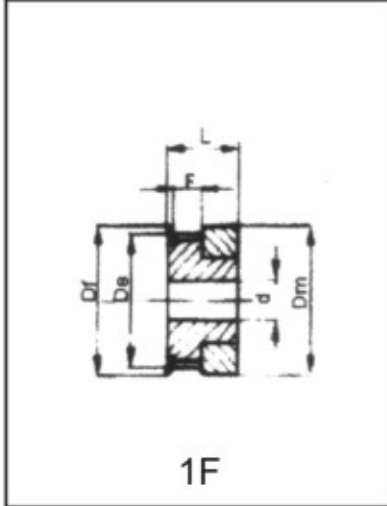



PLOT DELİKLİ TRİGER DİŞLİLER

T10 ---- AT10 ADIMLI TRİGER DİŞLİLER

T 10 B 16						
KOD CODE	TİP TYPE	d	Z	DP	F	L
12-T10 B 16F	2F	6	12	38.20	21	31
14-T10 B 16F	2F	8	14	44.56	21	31
16-T10 B 16F	2F	8	16	50.93	21	31
18-T10 B 16F	2F	8	18	57.30	21	31
20-T10 B 16F	2F	8	20	63.66	21	31
22-T10 B 16F	2F	8	22	70.03	21	31
24-T10 B 16F	2F	8	24	76.40	21	31
26-T10 B 16F	2F	8	26	82.76	21	31
28-T10 B 16F	2F	8	28	89.13	21	31
30-T10 B 16F	2F	8	30	95.50	21	31
32-T10 B 16F	2F	10	32	101.86	21	31
36-T10 B 16F	2F	10	36	114.59	21	31
40-T10 B 16F	2F	10	40	127.33	21	31
44-T10 B 16	2	10	44	140.06	21	31
48-T10 B 16	2	16	48	152.79	21	31
56-T10 B 16	2	16	56	178.26	21	31
64-T10 B 16	2	16	64	203.72	21	31
72-T10 B 16	2	16	72	229.19	21	31

T 10 B 25						
KOD CODE	TİP TYPE	d	Z	DP	F	L
12-T10 B 25F	2F	6	12	38.20	30	40
14-T10 B 25F	2F	8	14	44.56	30	40
16-T10 B 25F	2F	8	16	50.93	30	40
18-T10 B 25F	2F	8	18	57.30	30	40
20-T10 B 25F	2F	8	20	63.66	30	40
22-T10 B 25F	2F	8	22	70.03	30	40
24-T10 B 25F	2F	8	24	76.40	30	40
26-T10 B 25F	2F	8	26	82.76	30	40
28-T10 B 25F	2F	8	28	89.13	30	40
30-T10 B 25F	2F	8	30	95.50	30	40
32-T10 B 25F	2F	10	32	101.86	30	40
36-T10 B 25F	2F	10	36	114.59	30	40
40-T10 B 25F	2F	10	40	127.33	30	40
44-T10 B 25	2	10	44	140.06	30	40
48-T10 B 25	2	16	48	152.79	30	40
56-T10 B 25	2	16	56	178.26	30	40
64-T10 B 25	2	16	64	203.72	30	40
72-T10 B 25	2	16	72	229.19	30	40

T 10 B 32						
KOD CODE	TİP TYPE	d	Z	DP	F	L
12-T10 B 32F	2F	10	12	38.20	37	47
14-T10 B 32F	2F	12	14	44.56	37	47
16-T10 B 32F	2F	12	16	50.93	37	47
18-T10 B 32F	2F	12	18	57.30	37	47
20-T10 B 32F	2F	12	20	63.66	37	47
22-T10 B 32F	2F	12	22	70.03	37	47
24-T10 B 32F	2F	12	24	76.40	37	47
26-T10 B 32F	2F	12	26	82.76	37	47
28-T10 B 32F	2F	12	28	89.13	37	47
30-T10 B 32F	2F	12	30	95.50	37	47
32-T10 B 32F	2F	12	32	101.86	37	47
36-T10 B 32F	2F	12	36	114.59	37	47
40-T10 B 32F	2F	16	40	127.33	37	47
44-T10 B 32	2	16	44	140.06	37	47
48-T10 B 32	2	16	48	152.79	37	47
56-T10 B 32	2	16	56	178.26	37	47
64-T10 B 32	2	16	64	203.72	37	47
72-T10 B 32	2	20	72	229.19	37	47

T 10 B 50						
KOD CODE	TİP TYPE	d	Z	DP	F	L
12-T10 B 50F	2F	10	12	38.20	56	66
14-T10 B 50F	2F	12	14	44.56	56	66
16-T10 B 50F	2F	12	16	50.93	56	66
18-T10 B 50F	2F	12	18	57.30	56	66
20-T10 B 50F	2F	12	20	63.66	56	66
22-T10 B 50F	2F	12	22	70.03	56	66
24-T10 B 50F	2F	12	24	76.40	56	66
26-T10 B 50F	2F	12	26	82.76	56	66
28-T10 B 50F	2F	12	28	89.13	56	66
30-T10 B 50F	2F	12	30	95.50	56	66
32-T10 B 50F	2F	12	32	101.86	56	66
36-T10 B 50F	2F	16	36	114.59	56	66
40-T10 B 50F	2F	16	40	127.33	56	66
44-T10 B 50	2	16	44	140.06	56	66
48-T10 B 50	2	16	48	152.79	56	66
56-T10 B 50	2	16	56	178.26	56	66
64-T10 B 50	2	16	64	203.72	56	66
72-T10 B 50	2	20	72	229.19	56	66

TRİGER DİŞLİLER

MOTOR GÜCÜ VE DEVİR SAYISINA GÖRE DİŞLİ SEÇİMİ

devirler **RPM** (REVOLUTION)

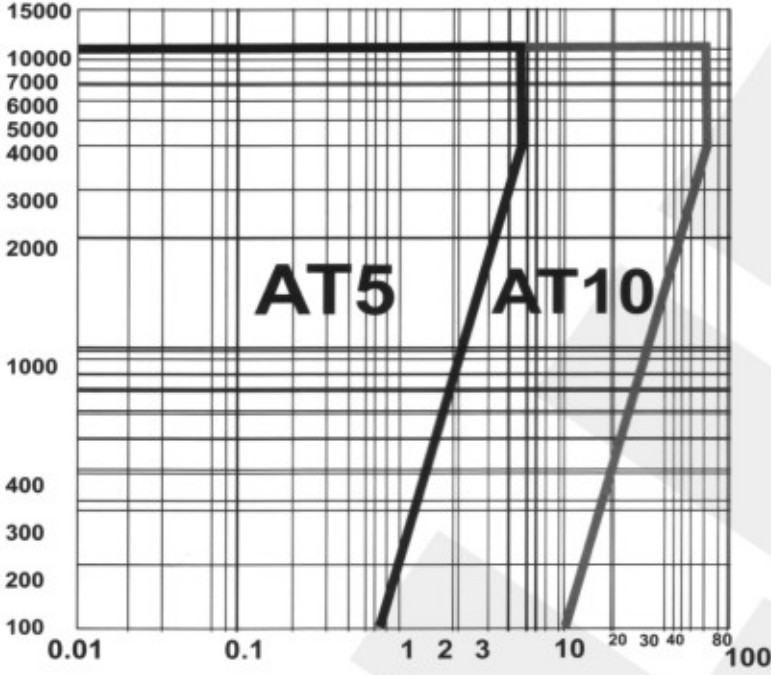

MOTOR GÜÇLERİ (KW) POWER (KW)



devirler **RPM** (REVOLUTION)

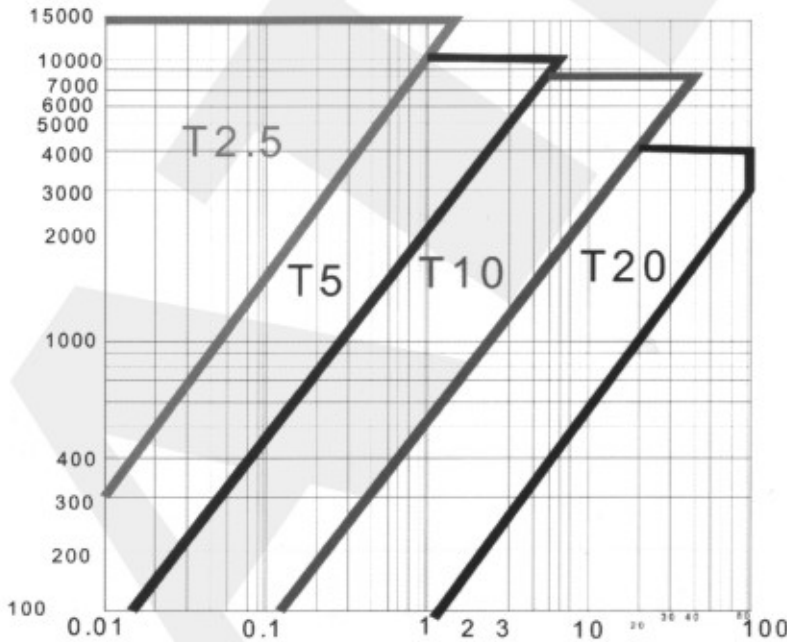

GÜÇLER (kw) / POWERS



TRİGER DİŞLİLER

MOTOR GÜCÜ VE DEVİR SAYISINA GÖRE DİŞLİ SEÇİMİ

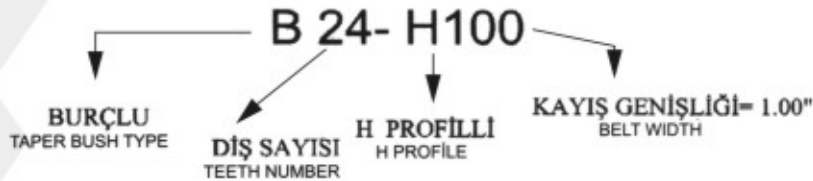
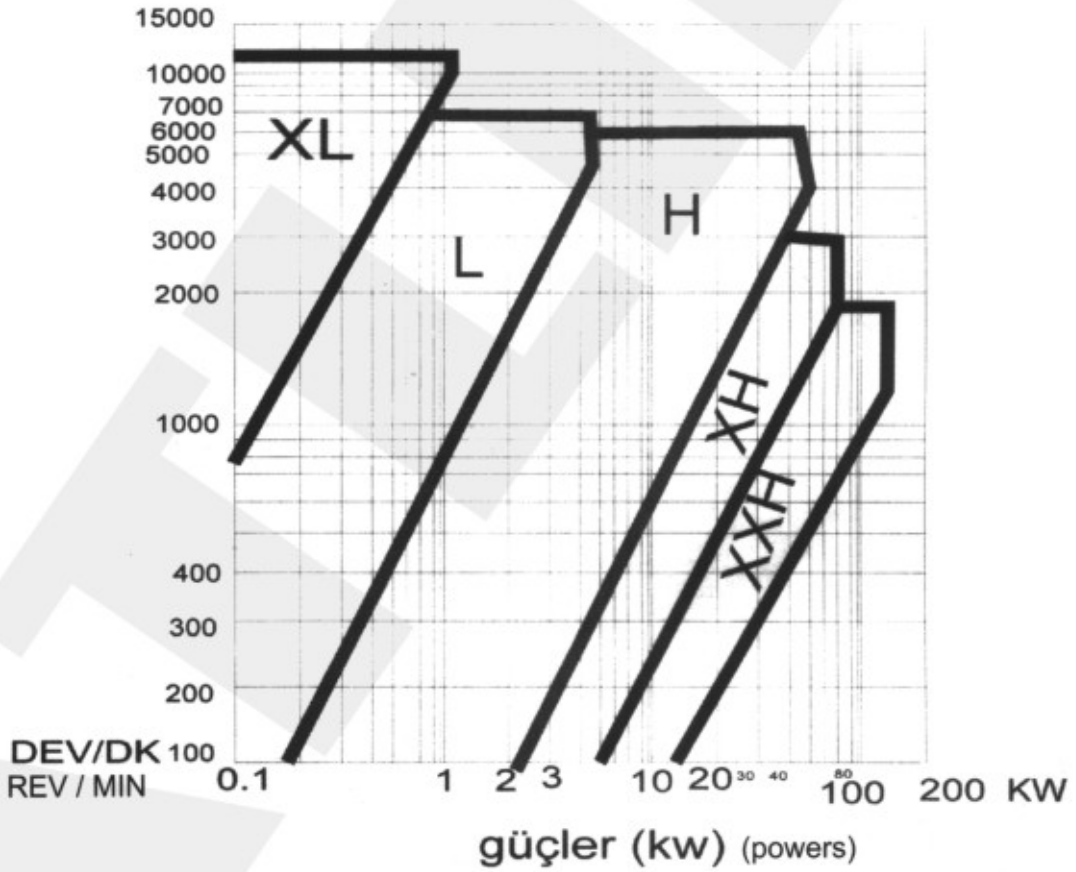

HTD TİP TRİGER DİŞLİLER

MOTOR GÜCÜ VE DEVİR SAYISINA GÖRE DİŞLİ SEÇİMİ



HTD (YÜKSEK GÜÇ İLETİMİNDE KULLANILIR)

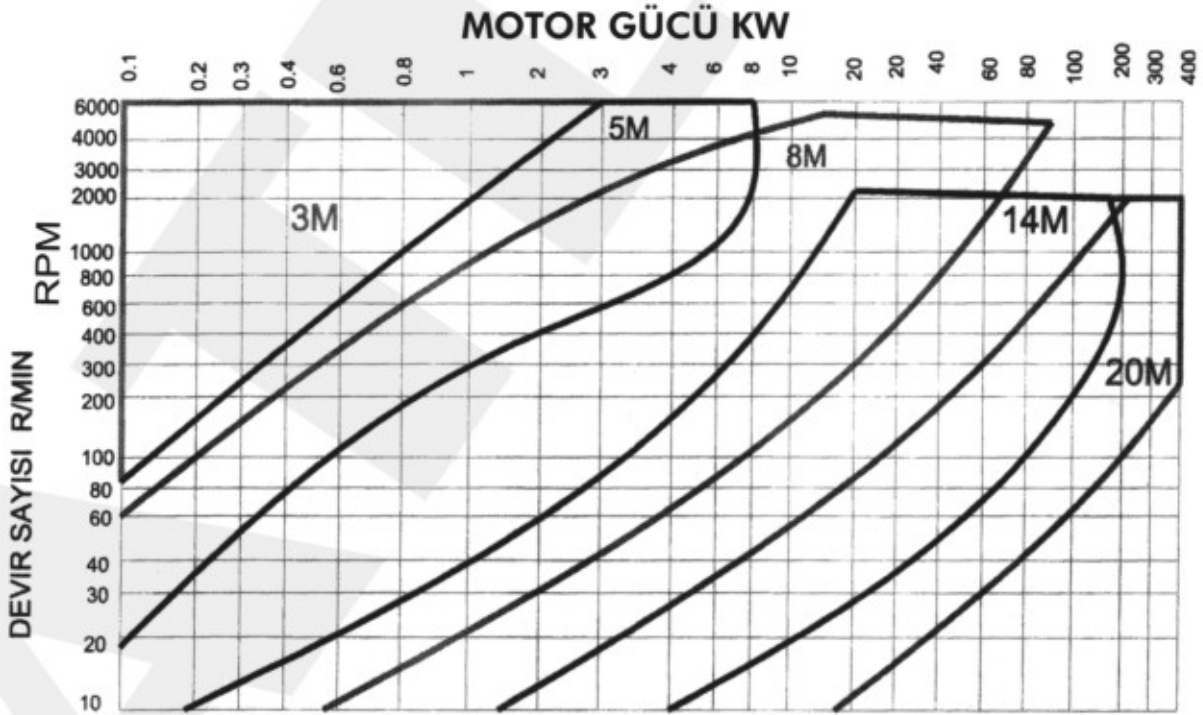

UYGUN TRİGER DİŞLİ SEÇİM DİYAĞRAMI



PLOT TİP TRİGER DİŞLİLER

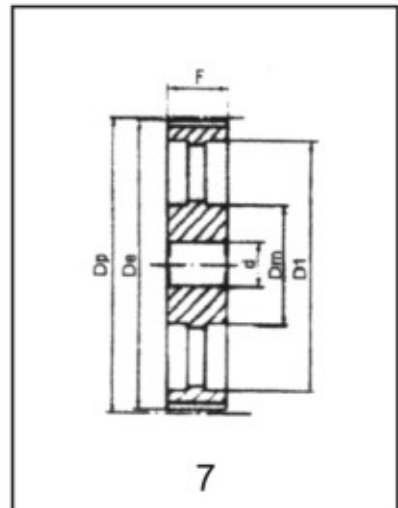
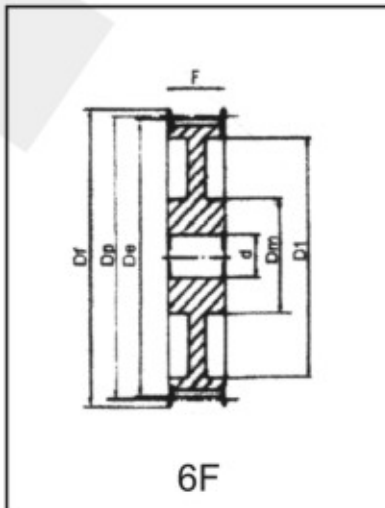
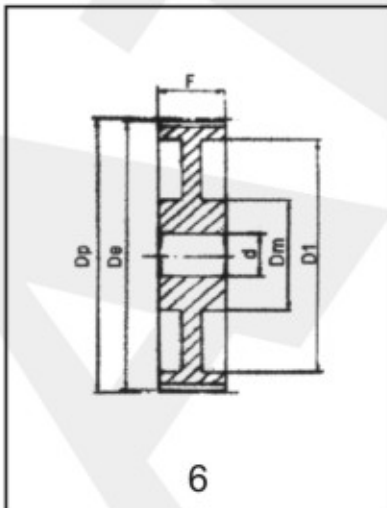
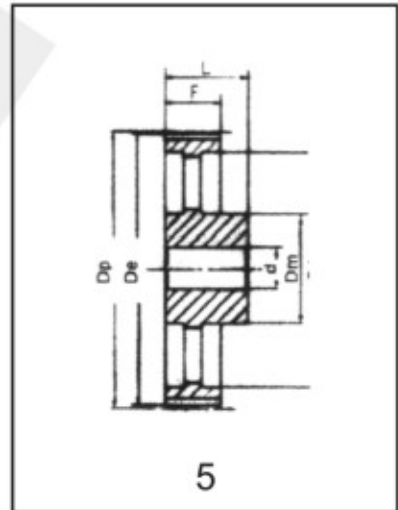
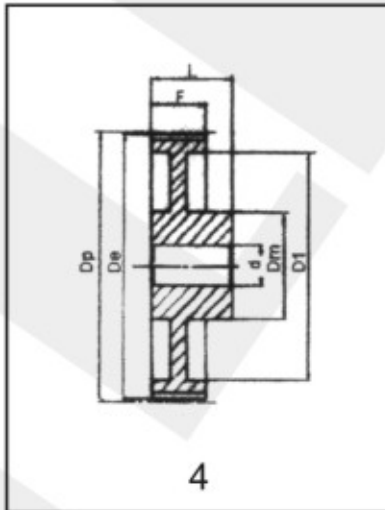
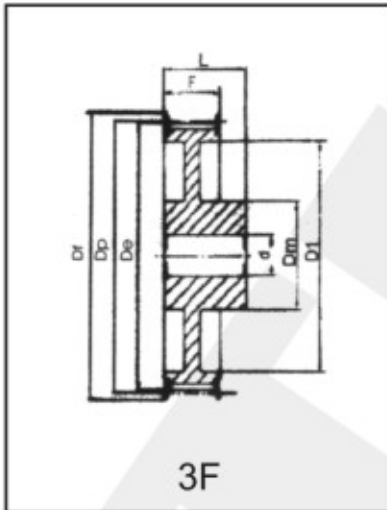
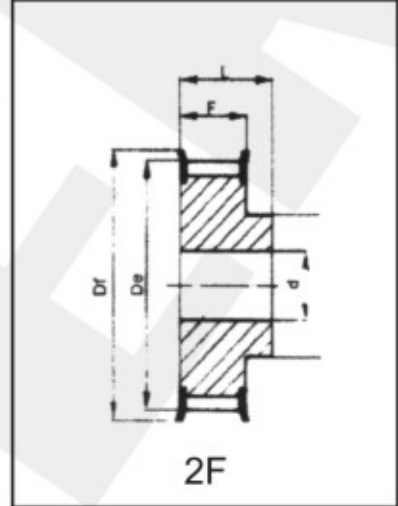
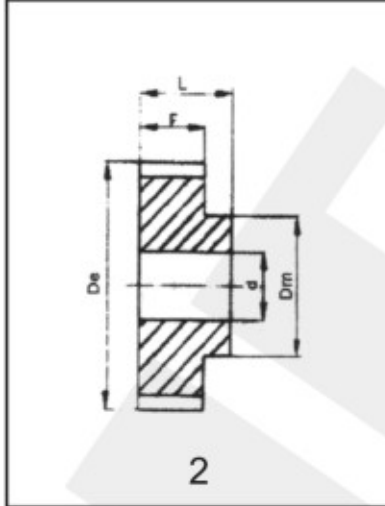
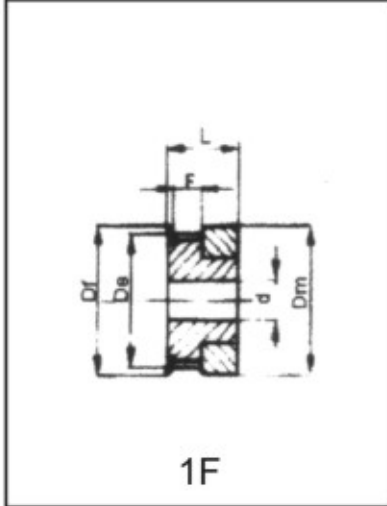



PLOT TİP TRİGER DİŞLİLER

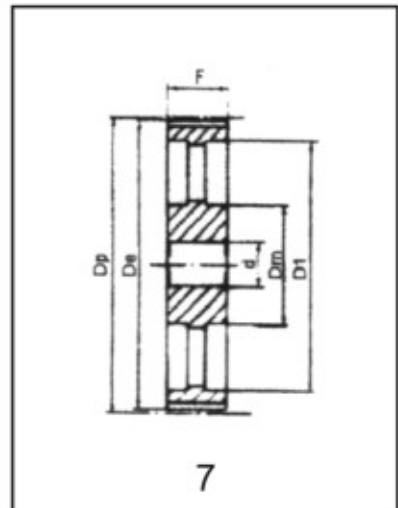
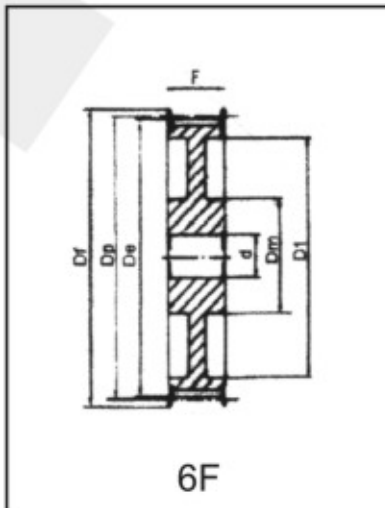
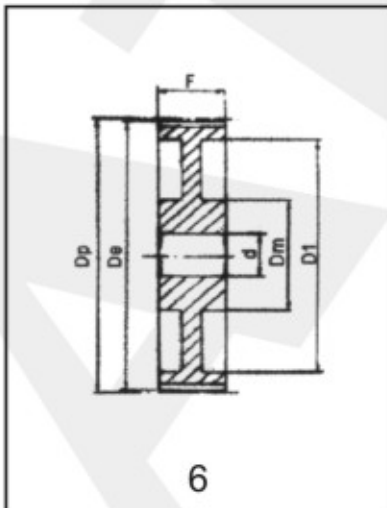
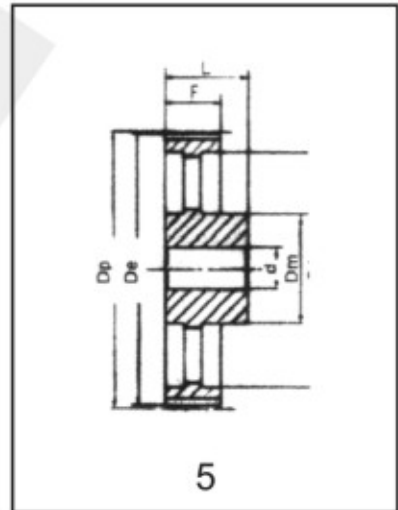
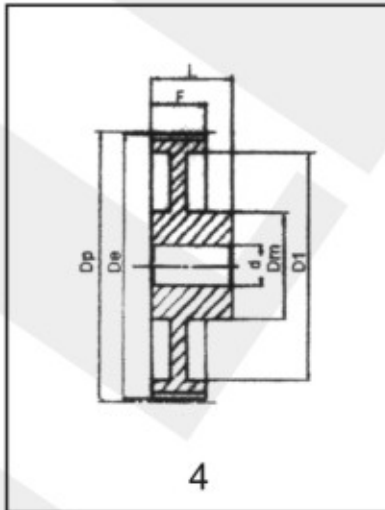
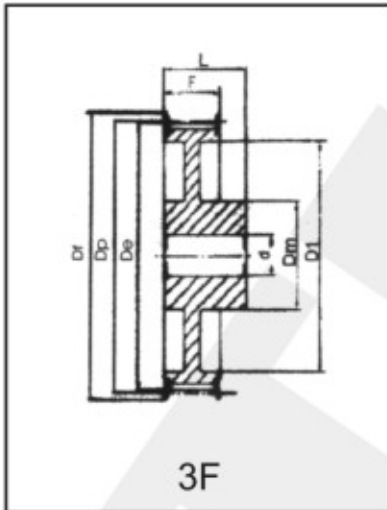
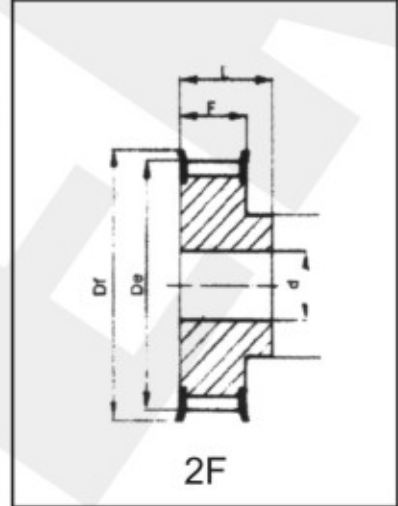
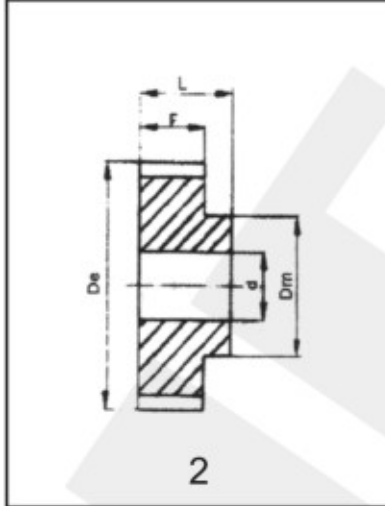
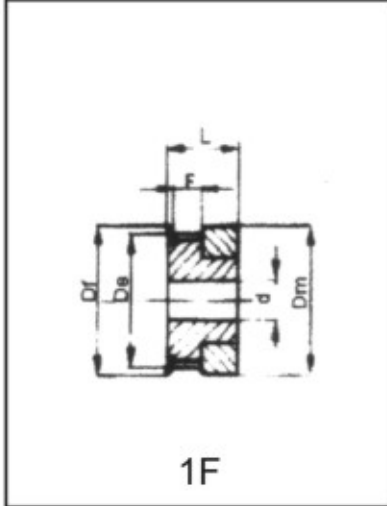



PLOT DELİKLİ TRİGER DİŞLİLER

XL (5,08 mm) ADIMLI TRİGER DİŞLİLER

XL 037								
KOD CODE	DIS SAYISI "Z" Teeth	TİP TYPE	EKSEN ÇAPI "Dp" Diameter	FATURA ÇAPI "Dm" Diameter	KADEME ÇAPI "Di" Pitch Diameter	DELİK ÇAPI "d" Bore Diameter	DIS BOYU "F" Teeth Dimension	TOPLAM BOY "L" Total
12XL037F	12	2F	19,4	9,5	-	4	15	23
14 XL 037F	14	2F	22,64	10	-	4	15	23
16XL037F	16	2F	25,87	15	-	5	15	23
18 XL037F	18	2F	29,11	20	-	5	15	23
20 XL 037F	20	2F	32,34	22	-	5	15	23
24 XL 037F	24	2F	38,81	30	-	6	15	23
25 XL 037F	25	2F	40,43	33	-	6	15	23
28 XL 037F	28	2F	45,28	34	-	8	15	23
30 XL 037F	30	2F	48,51	38	-	8	15	23
32 XL 037 F	32	2F	51,75	38	-	8	15	25
36 XL 037	36	2F	58,21	45	-	8	15	25
40 XL 037	40	2F	64,68	45	-	8	15	25
44 XL 037	44	2F	71,15	45	-	10	15	25
48 XL 037	48	2F	77,62	45	-	10	15	25
50 XL 037	50	2	80,85	45	-	10	15	25
56 XL 037	56	2	90,56	45	-	10	15	25
60 XL 037	60	2	97,02	45	-	10	15	25
64 XL 037	64	2	103,49	45	-	10	15	25
70 XL 037	70	2	113,19	45	-	10	15	25
72 XL 037	72	2	116,43	45	-	12	15	25
76 XL 037	76	2	122,9	45	-	12	15	25
80 XL 037	80	2	129,36	50	-	12	15	28
96 XL 037	96	2	155,24	50	-	15	15	28



PLOT TİP TRİGER DİŞLİLER

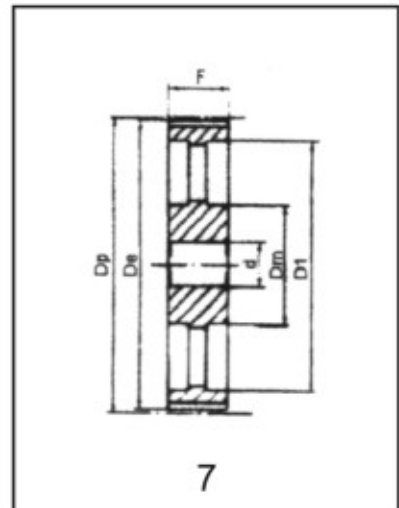
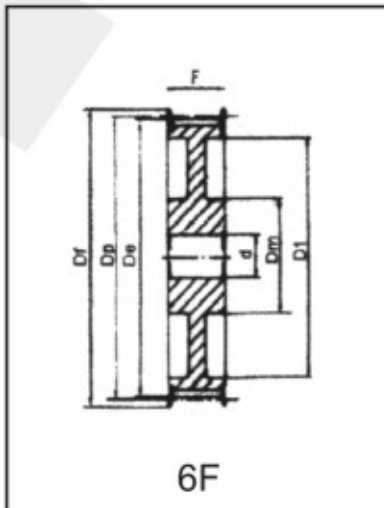
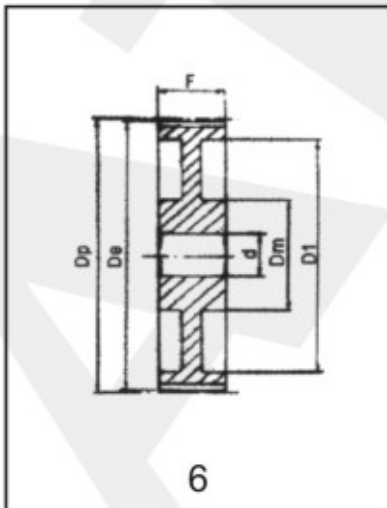
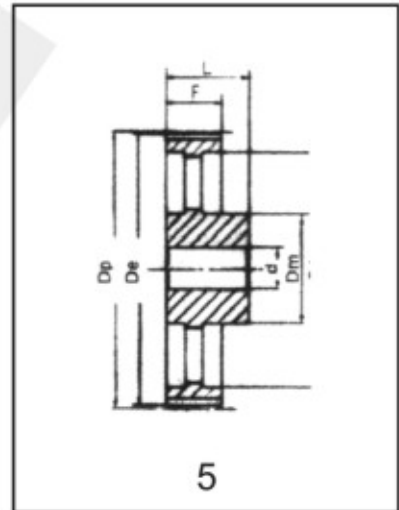
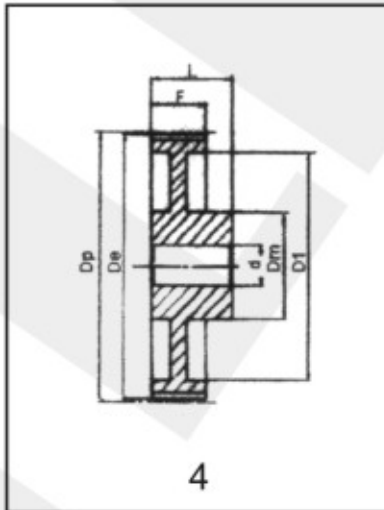
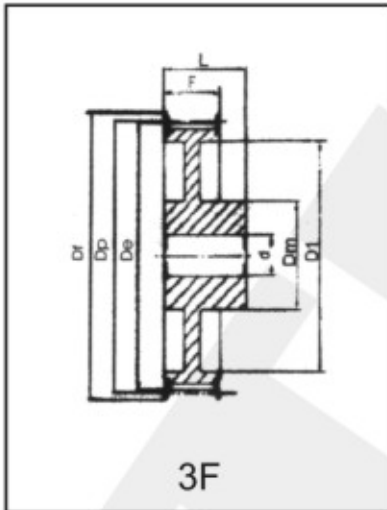
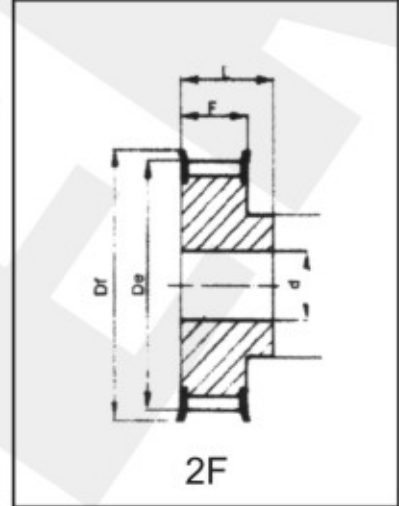
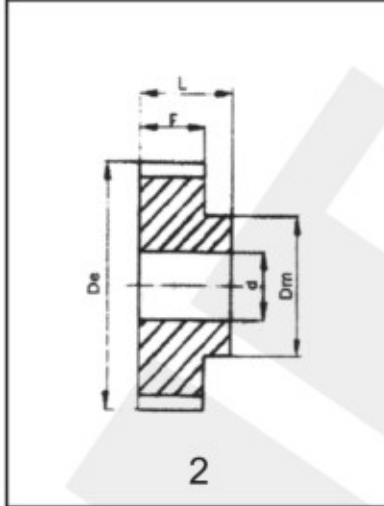
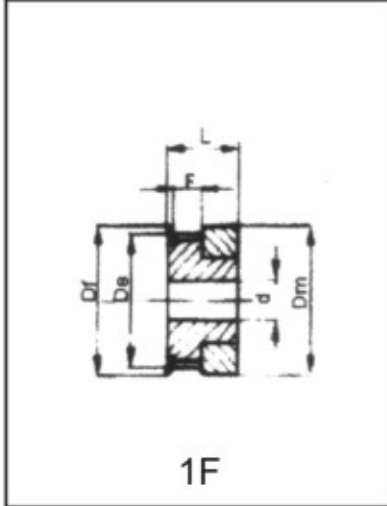



PLOT DELİKLİ TRİGER DİŞLİLER

L (9,525 mm) ADIMLI TRİGER DİŞLİLER

L050

KOD CODE	TİP TYPE	d	Z	DP	F	L
10-L050 F	2F	8	10	30.32	19	28
12-L050 F	2F	8	12	36.38	19	30
14-L050 F	2F	10	14	42.45	19	30
16-L050 F	2F	10	16	48.51	19	32
18-L050 F	2F	10	18	54.58	19	32
20-L050 F	2F	10	20	60.64	19	32
22-L050 F	2F	10	22	66.70	19	32
24-L050 F	2F	10	24	72.77	19	32
26-L050 F	2F	12	26	78.83	19	32
28-L050 F	2F	12	28	84.90	19	32
30-L050 F	2F	12	30	90.96	19	32
32-L050 F	2F	12	32	97.02	19	32
34-L050 F	2F	12	34	103.09	19	32
36-L050 F	2F	12	36	109.15	19	32
40-L050 F	2F	12	40	121.28	19	32
44-L050 F	2F	12	44	133.41	19	32
48-L050 F	2F	14	48	145.54	19	32
56-L050	2	14	56	169.79	19	32
60-L050	2	14	60	181.92	19	32
72-L050	2	14	72	218.30	19	32
80-L050	2	14	80	242.56	19	32
90-L050	2	14	90	272.88	19	32

L075

KOD CODE	TİP TYPE	d	Z	DP	F	L
10-L075 F	2F	8	10	30.32	25.5	38
12-L075 F	2F	8	12	36.38	25.5	38
14-L075 F	2F	12	14	42.45	25.5	38
16-L075 F	2F	12	16	48.51	25.5	38
18-L075 F	2F	12	18	54.58	25.5	38
20-L075 F	2F	12	20	60.64	25.5	38
22-L075 F	2F	12	22	66.70	25.5	38
24-L075 F	2F	12	24	72.77	25.5	38
26-L075 F	2F	12	26	78.83	25.5	38
28-L075 F	2F	12	28	84.90	25.5	38
30-L075 F	2F	12	30	90.96	25.5	38
32-L075 F	2F	12	32	97.02	25.5	38
34-L075 F	2F	12	34	103.09	25.5	38
36-L075 F	2F	12	36	109.15	25.5	38
40-L075 F	2F	12	40	121.28	25.5	38
44-L075 F	2F	12	44	133.41	25.5	38
48-L075 F	2F	14	48	145.54	25.5	38
56-L075	2	14	56	169.79	25.5	38
60-L075	2	14	60	181.92	25.5	38
72-L075	2	14	72	218.30	25.5	45
80-L075	2	14	80	242.56	25.5	45
90-L075	2	14	90	272.88	25.5	45

L100

KOD CODE	TİP TYP E	d	Z	DP	F	L
10-L100 F	2F	8	10	30.32	32	45
12-L100 F	2F	8	12	36.38	32	45
14-L100 F	2F	12	14	42.45	32	45
16-L100 F	2F	12	16	48.51	32	45
18-L100 F	2F	12	18	54.58	32	45
20-L100 F	2F	14	20	60.64	32	45
22-L100 F	2F	14	22	66.70	32	45
24-L100 F	2F	14	24	72.77	32	45
26-L100 F	2F	14	26	78.83	32	45
28-L100 F	2F	14	28	84.90	32	45
30-L100 F	2F	14	30	90.96	32	45
32-L100 F	2F	14	32	97.02	32	45
34-L100 F	2F	14	34	103.09	32	45
36-L100 F	2F	14	36	109.15	32	45
40-L100 F	2F	14	40	121.28	32	45
44-L100 F	2F	14	44	133.41	32	45
48-L100 F	2F	14	48	145.54	32	45
56-L050	2	14	56	169.79	32	45
60-L050	2	14	60	181.92	32	45
72-L050	2	14	72	218.30	32	45
80-L050	2	14	80	242.56	32	45
90-L050	2	14	90	272.88	32	45



PLOT TİP TRİGER DİŞLİLER

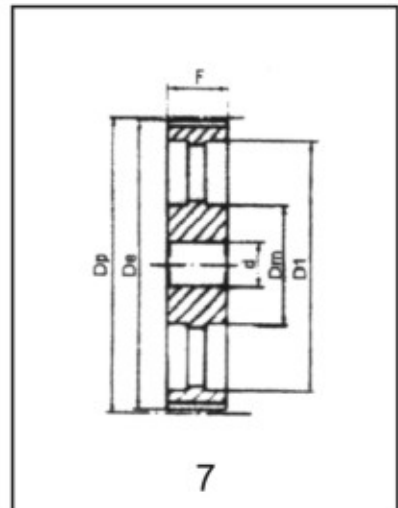
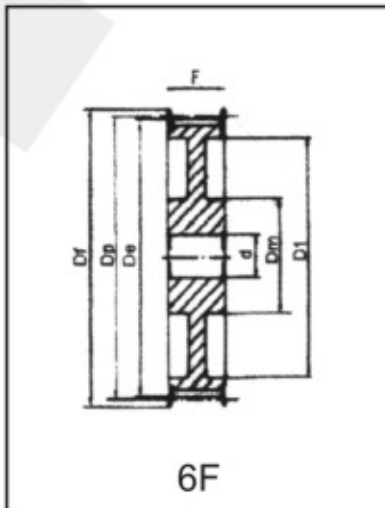
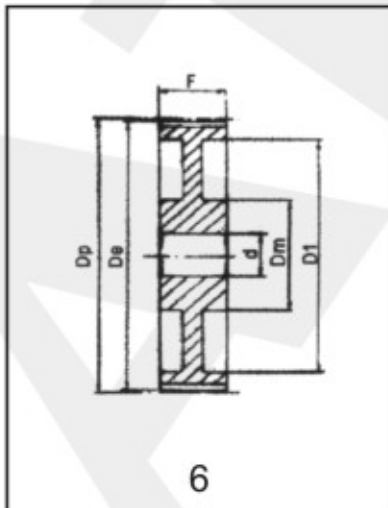
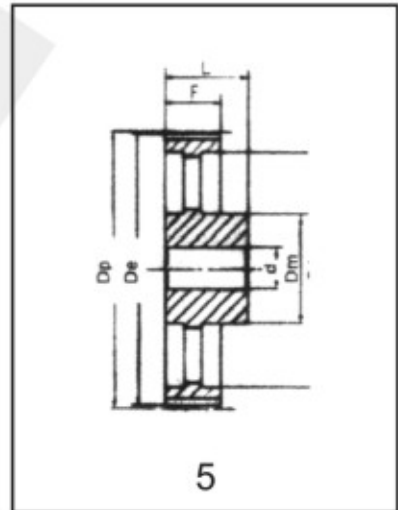
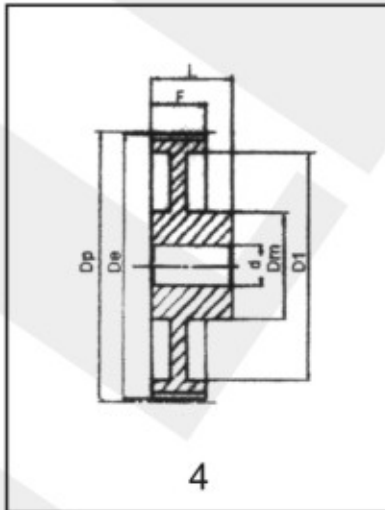
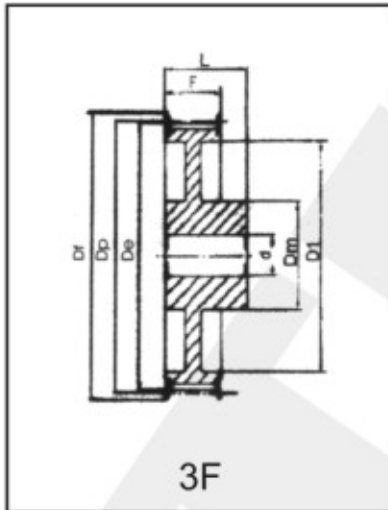
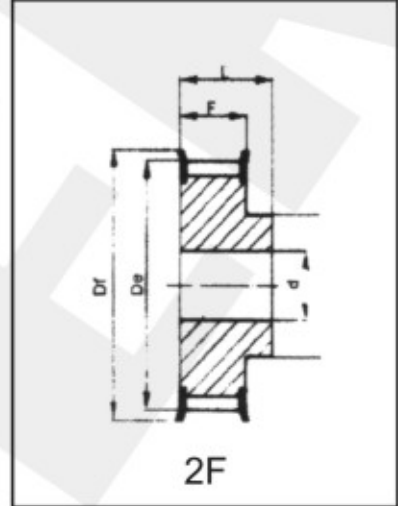
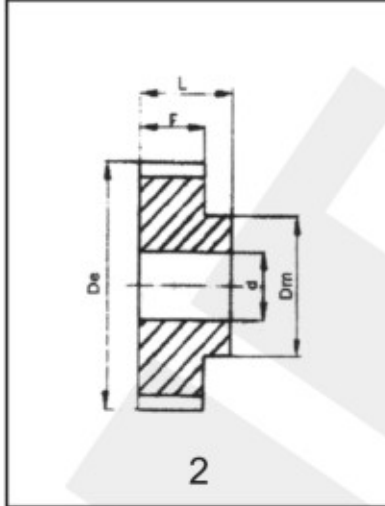
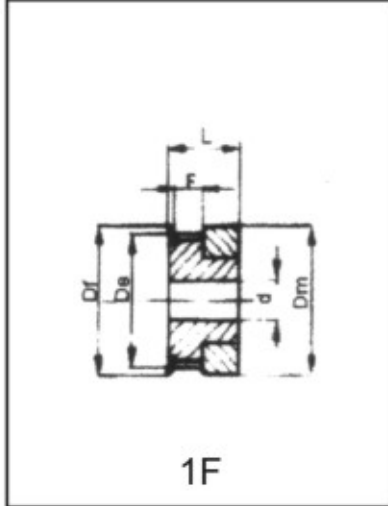



PLOT DELİKLİ TRİGER DİŞLİLER

H (12,7 mm) ADIMLI TRİGER DİŞLİLER

H 100

KOD CODE	TIP TYPE	d	Z	DP	F	L
14- H100 F	2F	12	14	56,6	32	45
16- H100 F	2F	12	16	64,68	32	45
18- H100 F	2F	12	18	72,77	32	45
20- H100 F	2F	14	20	80,85	32	45
22- H100 F	2F	14	22	88,94	32	45
24- H100 F	2F	14	24	97,02	32	45
26- H100 F	2F	14	26	105,11	32	45
28- H100 F	2F	14	28	113,19	32	45
30- H100 F	2F	14	30	121,28	32	45
32- H100 F	2F	14	32	129,36	32	45
34- H100 F	2F	14	34	137,45	32	45
36- H100 F	2F	14	36	145,54	32	45
40- H100 F	2F	14	40	161,71	32	45
44- H100 F	2F	14	44	177,88	32	50
48- H100 F	2	20	48	194,05	32	50
56 H100	2	20	59	238,52	32	50
60- H100	2	20	60	242,56	32	50
72- H100	2	20	72	291,07	32	50
80- H100	2	20	80	323,41	32	50
90- H100	2	20	90	363,839	32	50
96- H100	4	20	96	388,095	32	50
120- H100	4	20	120	485,119	32	50
150- H100	4	20	150	606,398	32	50

H 150

KOD CODE	TIP TYPE	d	Z	DP	F	L
14- H150 F	2F	20	14	56,6	46	58
16- H150 F	2F	20	16	64,68	46	58
18- H150 F	2F	20	18	72,77	46	58
20- H150 F	2F	20	20	80,85	46	58
22- H150 F	2F	20	22	88,94	46	58
24- H150 F	2F	20	24	97,02	46	58
26- H150 F	2F	20	26	105,11	46	58
28- H150 F	2F	20	28	113,19	46	58
30- H150 F	2F	20	30	121,28	46	58
32- H150 F	2F	20	32	129,36	46	58
34- H150 F	2F	20	34	137,45	46	58
36- H150 F	2F	20	36	145,54	46	58
40- H150 F	2F	20	40	161,71	46	58
44- H150 F	2F	20	44	177,88	46	58
48- H150 F	2	20	48	194,05	46	65
56 H150	2	20	59	238,52	46	65
60- H150	2	20	60	242,56	46	65
72- H150	2	20	72	291,07	46	65
80- H150	2	20	80	323,41	46	65
90- H150	2	25	90	363,839	46	65
96- H150	4	25	96	388,095	46	65
120- H150	4	25	120	485,119	46	65
150- H150	4	25	150	606,398	46	65

H 200

KOD CODE	TIP TYPE	d	Z	DP	F	L
14- H200 F	2F	20	14	56,6	59	70
16- H200 F	2F	20	16	64,68	59	70
18- H200 F	2F	20	18	72,77	59	70
20- H200 F	2F	20	20	80,85	59	70
22- H200 F	2F	20	22	88,94	59	70
24- H200 F	2F	20	24	97,02	59	70
26- H200 F	2F	20	26	105,11	59	70
28- H200 F	2F	20	28	113,19	59	70
30- H200 F	2F	20	30	121,28	59	70
32- H200 F	2F	20	32	129,36	59	70
34- H200 F	2F	20	34	137,45	59	70
36- H200 F	2F	20	36	145,54	59	70
40- H200 F	2F	20	40	161,71	59	70
44- H200 F	2F	25	44	177,88	59	70
48- H200 F	2	25	48	194,05	59	70
56 H200	2	25	59	238,52	59	70
60- H200	2	25	60	242,56	59	70
72- H200	2	25	72	291,07	59	70
80- H200	2	25	80	323,41	59	70
90- H200	2	25	90	363,839	59	70
96- H200	4	25	96	388,09	59	70
120- H200	4	25	120	485,12	59	70
150- H200	4	25	150	606,4	59	70



PLOT TİP TRİGER DİŞLİLER

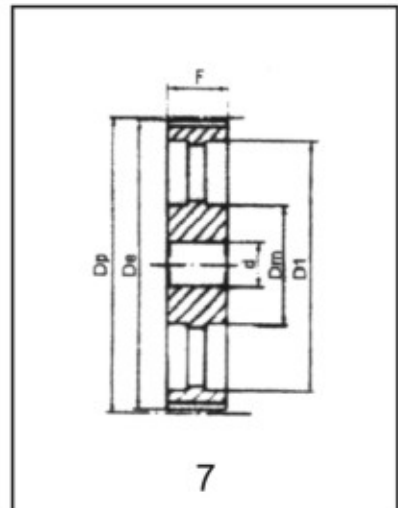
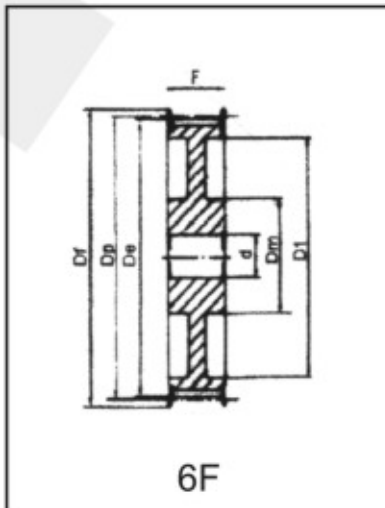
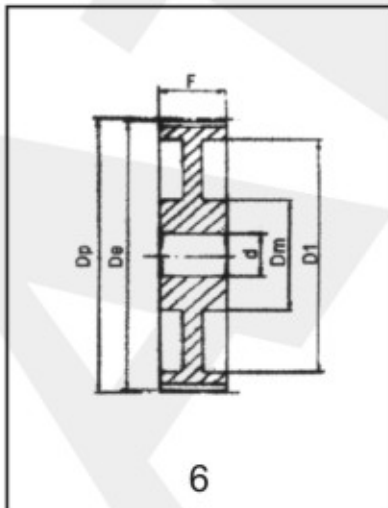
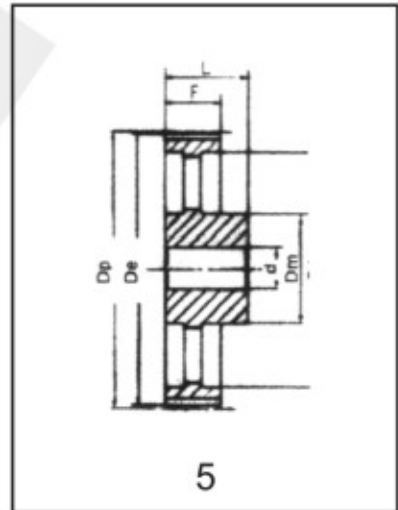
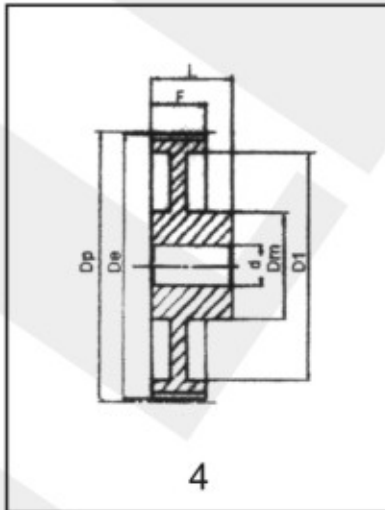
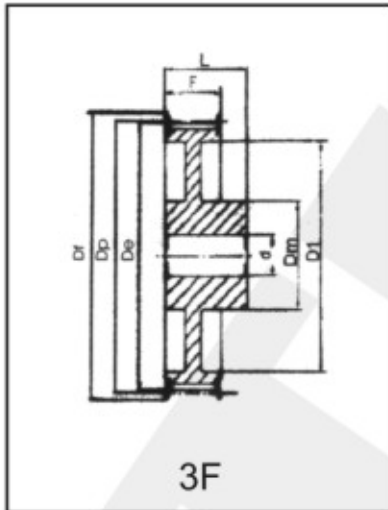
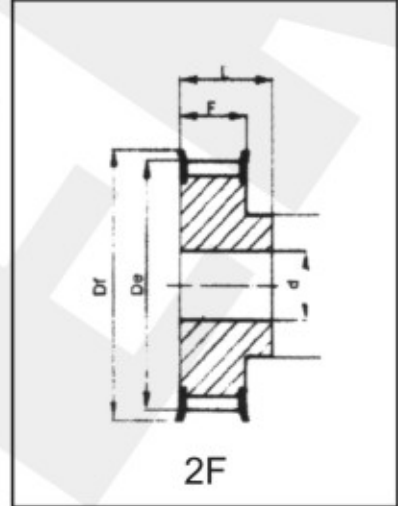
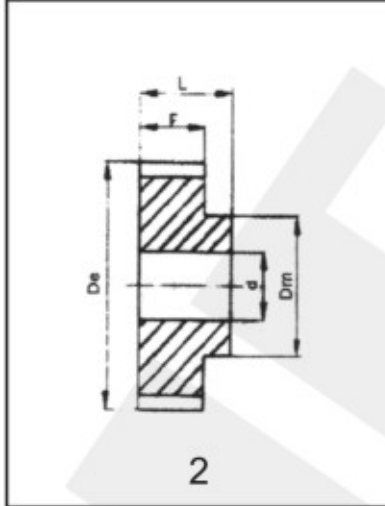
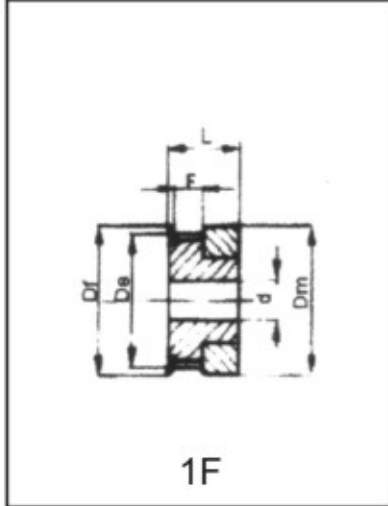



HTD TİP PLOT DELİKLİ TRİGER DİŞLİLER

HTD 3M (3 mm) ADIMLI TRİGER DİŞLİLER

HTD 3 M- 09						
KOD CODE	TİP TYPE	d	Z	DP	F	L
12- 3M-09F	1F	0	12	11.46.	14.5	20
14- 3M-09F	1F	0	14	13.37	14.5	20
16- 3M-09F	2F	0	16	15.28	14.5	20
18- 3M-09F	2F	6	18	17.19	14.5	20
20- 3M-09F	2F	6	20	19.10	14.5	20
22- 3M-09F	2F	6	22	21.1	14.5	20
24- 3M-09F	2F	6	24	22.92	14.5	20
26- 3M-09F	2F	6	26	24.83	14.5	20
28- 3M-09F	2F	6	28	26.74	14.5	20
30- 3M-09F	2F	6	30	28.65	14.5	20
32-3M-09F	2F	6	32	30.56	14.5	20
34- 3M-09F	2F	6	34	32.47	14.5	20
36- 3M-09F	2F	6	36	34.38	14.5	20
38- 3M-09F	2F	6	38	36.29	14.5	20
40-3M-09F	2F	6	40	38.20	14.5	20
44- 3M-09	2F	6	44	42.02	14.5	20
48- 3M-09	2	8	48	45.84	14.5	20
56- 3M-09	2	8	56	53.48	14.5	20
64- 3M-09	2	8	64	61.12	14.5	20
72- 3M-09	2	8	72	68.76	14.5	20
80- 3M-09	2	10	80	76.40	14.5	20
90- 3M-09	2	10	90	85.95	14.5	20
112- 3M-09	2	12	112	106.96	14.5	20
144- 3M-09	4	12	144	137.51	14.5	20



PLOT TİP TRİGER DİŞLİLER

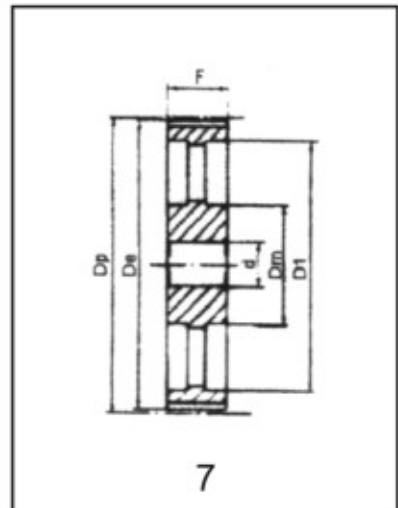
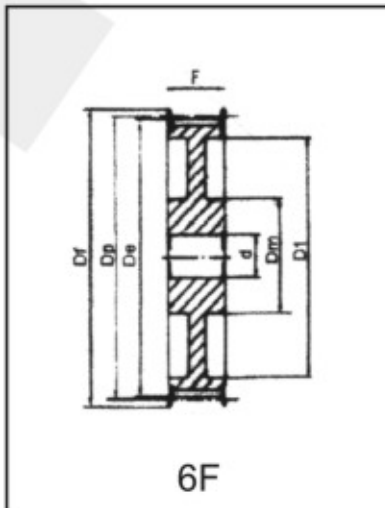
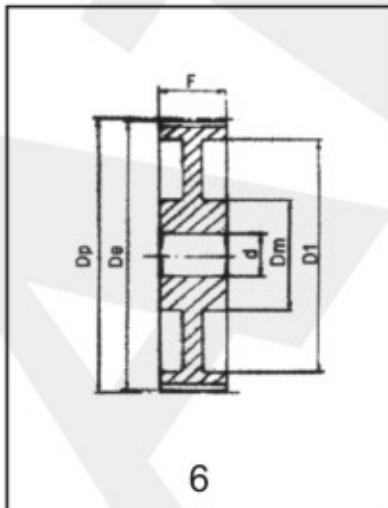
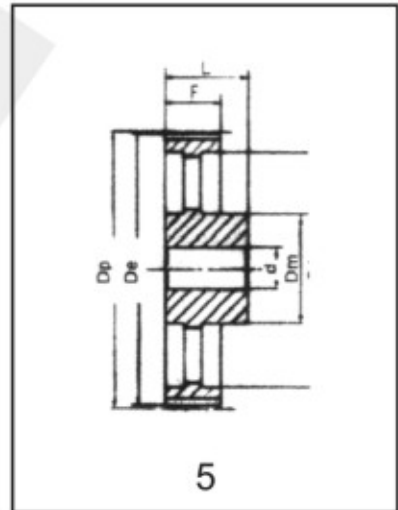
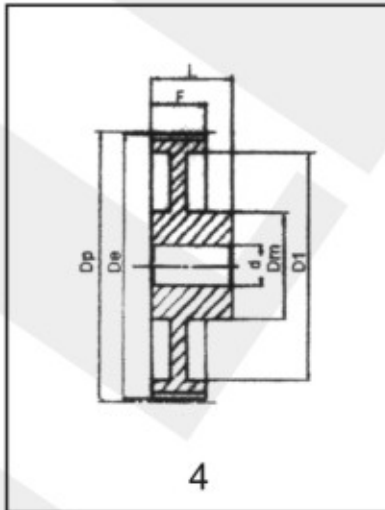
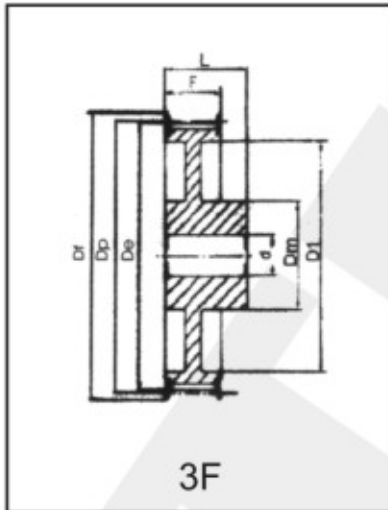
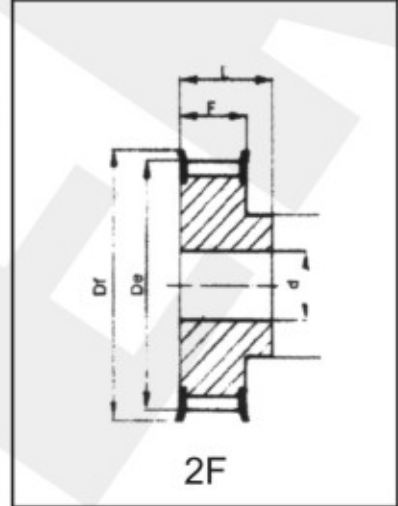
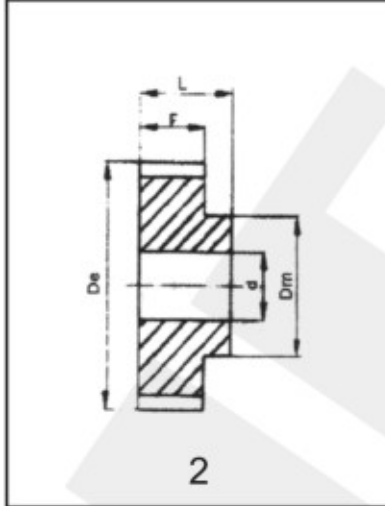
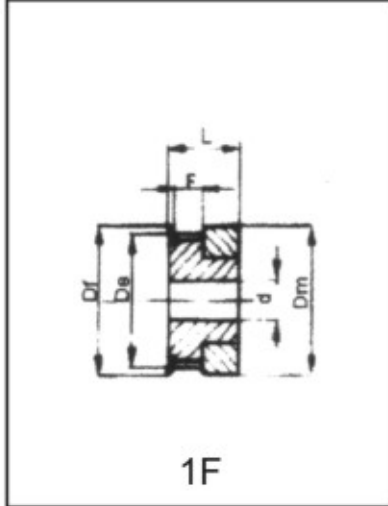



HTD TİP PLOT DELİKLİ TRİGER DİŞLİLER

HTD 5M (5 mm) ADIMLI TRİGER DİŞLİLER

HTD 5 M- 15						
KOD CODE	TİP TYPE	d	Z	DP	F	L
12- 5M-15F	2F	6	12	19.10	20.5	26
14- 5M-15F	2F	6	14	22.28	20.5	26
16- 5M-15F	2F	6	16	25.47	20.5	26
18- 5M-15F	2F	6	18	28.65	20.5	26
20- 5M-15F	2F	6	20	31.83	20.5	26
22- 5M-15F	2F	8	22	35.02	20.5	26
24- 5M-15F	2F	8	24	38.20	20.5	26
26- 5M-15F	2F	8	26	41.38	20.5	26
28- 5M-15F	2F	8	28	44.56	20.5	26
30- 5M-15F	2F	8	30	47.75	20.5	26
32- 5M-15F	2F	8	32	50.93	20.5	26
34- 5M-15F	2F	8	34	54.11	20.5	26
36- 5M-15F	2F	8	36	57.30	20.5	26
38- 5M-15F	2F	8	38	60.48	20.5	26
40- 5M-15F	2F	8	40	63.66	20.5	26
44- 5M-15	4	8	44	70.03	20.5	26
48- 5M-15	4	10	48	76.40	20.5	26
56- 5M-15	4	10	56	89.13	20.5	26
64- 5M-15	4	10	64	101.86	20.5	26
72- 5M-15	4	10	72	114.59	20.5	26
80- 5M-15	4	12	80	127.33	20.5	26
90- 5M-15	4	12	90	143.24	20.5	26
112- 5M-15	4	14	112	178.26	20.5	26
144- 5M-15	4	14	144	229.19	20.5	26

HTD 5 M- 25						
KOD CODE	TİP TYPE	d	Z	DP	F	L
12- 5M-25F	2F	6	12	19.10"	20.5	26
14- 5M-25F	2F	6	14	22.28	20.5	26
16- 5M-25F	2F	6	16	25.47	20.5	26
18- 5M-25F	2F	6	18	28.65	20.5	26
20- 5M-25F	2F	6	20	31.83	20.5	26
22- 5M-25F	2F	8	22	35.02	20.5	26
24- 5M-25F	2F	8	24	38.20	20.5	26
26- 5M-25F	2F	8	26	41.38	20.5	26
28- 5M-25F	2F	8	28	44.56	20.5	26
30- 5M-25F	2F	8	30	47.75	20.5	26
32- 5M-25F	2F	8	32	50.93	20.5	26
34- 5M-25F	2F	8	34	54.11	20.5	26
36- 5M-25F	2F	8	36	57.30	20.5	26
38- 5M-25F	2F	8	38	60.48	20.5	26
40- 5M-25F	2F	8	40	63.66	20.5	26
44- 5M-25	4	8	44	70.03	20.5	26
48- 5M-25	4	10	48	76.40	20.5	26
56- 5M-25	4	10	56	89.13	20.5	26
64- 5M-25	4	10	64	101.86	20.5	26
72- 5M-25	4	10	72	114.59	20.5	26
80- 5M-25	4	12	80	127.33	20.5	26
90- 5M-25	4	12	90	143.24	20.5	26
112- 5M-25	4	14	112	178.26	20.5	26
144- 5M-25	4	14	144	229.19	20.5	26



PLOT TİP TRİGER DİŞLİLER

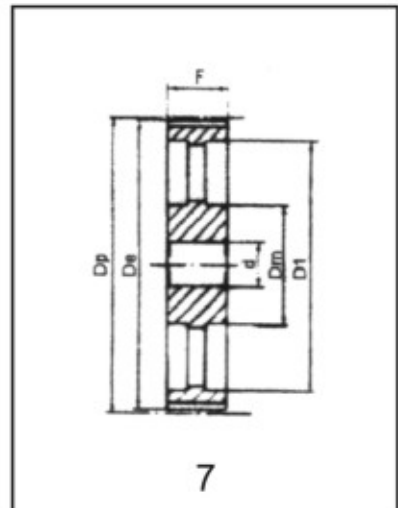
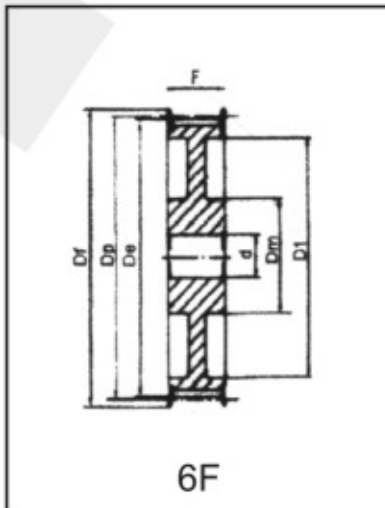
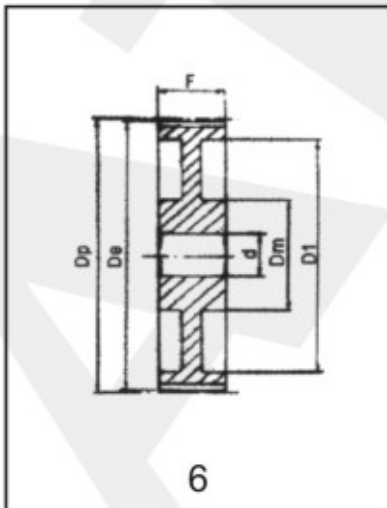
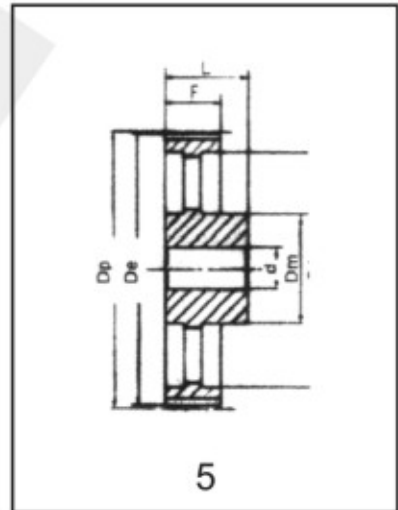
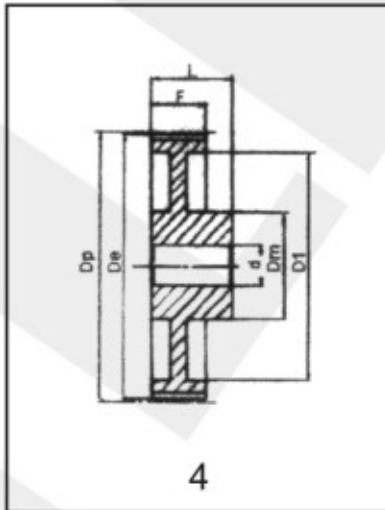
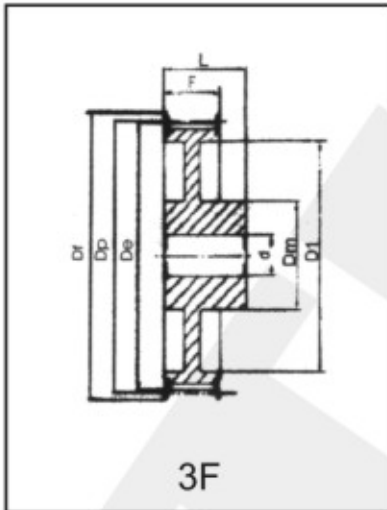
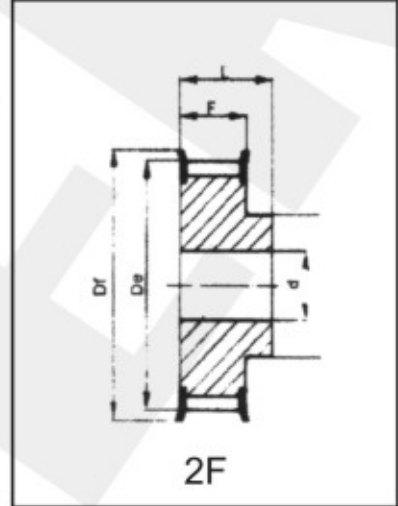
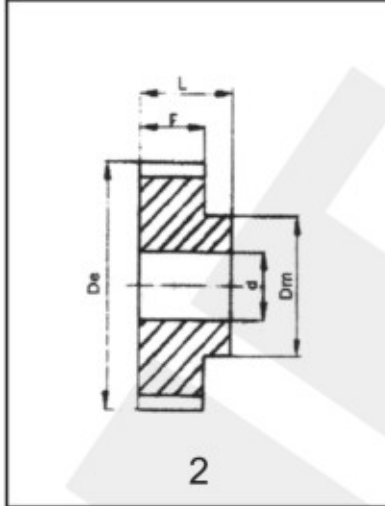
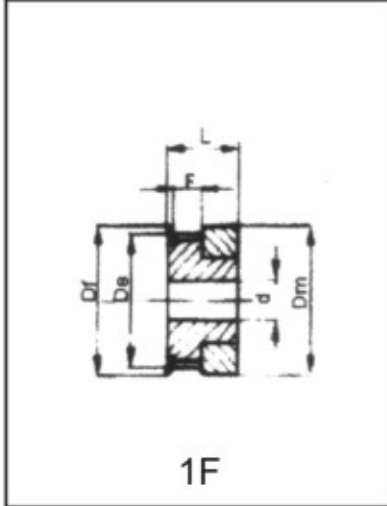



HTD TİP PLOT DELİKLİ TRİGER DİŞLİLER

HTD 8M (8 mm) ADIMLI TRİGER DİŞLİLER

HDT 8M-30						
KOD CODE	TİP TYPE	d	Z	DP	F	L
16- 8M-30F	2F	10	16	40.74	38	48
18- 8M-30F	2F	10	18	45.84	38	48
20- 8M-30F	2F	10	20	50.93	38	48
22- 8M-30F	2F	12	22	56.02	38	48
24- 8M-30F	2F	12	24	61.12	38	48
26- 8M-30F	2F	12	26	66.21	38	48
28- 8M-30F	2F	16	28	71.30	38	48
30- 8M-30F	2F	16	30	76.40	38	48
32- 8M-30F	2F	16	32	81.49	38	48
34- 8M-30F	2F	16	34	86.58	38	48
36- 8M-30F	2F	16	36	91.68	38	48
38- 8M-30F	2F	16	38	96.77	38	48
40- 8M-30F	2F	16	40	101.86	38	48
44- 8M-30F	2F	16	44	112.05	38	48
48- 8M-30F	2F	16	48	122.23	38	48
56- 8M-30F	3F	16	56	142.61	38	48
64- 8M-30F	3F	16	64	162.98	38	48
72- 8M-30F	3F	16	72	183.35	38	48
80- 8M-30	4	20	80	203.72	38	48
90- 8M-30	4	20	90	229.19	38	48
112- 8M-30	5	20	112	285.21	38	48
144- 8M-30	5	20	144	366.70	38	48

HDT 8M-50						
KOD CODE	TİP TYPE	d	Z	DP	F	L
16- 8M-50F	2F	10	16	40.74	60	70
18- 8M-50F	2F	10	18	45.84	60	70
20- 8M-50F	2F	10	20	50.93	60	70
22- 8M-50F	2F	12	22	56.02	60	70
24- 8M-50F	2F	12	24	61.12	60	70
26- 8M-50F	2F	12	26	66.21	60	70
28- 8M-50F	2F	16	28	71.30	60	70
30- 8M-50F	2F	16	30	76.40	60	70
32- 8M-50F	2F	16	32	81.49	60	70
34- 8M-50F	2F	16	34	86.58	60	70
36- 8M-50F	2F	16	36	91.68	60	70
38- 8M-50F	2F	18	38	96.77	60	70
40- 8M-50F	2F	18	40	101.86	60	70
44- 8M-50F	2F	18	44	112.05	60	70
48- 8M-50F	2F	18	48	122.23	60	70
56- 8M-50F	6F	18	56	142.61	60	70
64- 8M-50F	6F	18	64	162.98	60	70
72- 8M-50F	6F	18	72	183.35	60	70
80- 8M-50	4	20	80	203.72	60	70
90- 8M-50	4	20	90	229.19	60	70
112- 8M-50	5	20	112	285.21	60	70
144- 8M-50	5	20	144	366.70	60	70

HDT 8M-85						
KOD CODE	TİP TYPE	d	Z	DP	F	L
16- 8M-85F	2F	10	16	40.74	98	108
18- 8M-85F	2F	10	18	45.84	98	108
20- 8M-85F	2F	10	20	50.93	98	108
22- 8M-85F	2F	12	22	56.02	98	108
24- 8M-85F	2F	12	24	61.12	98	108
26- 8M-85F	2F	12	26	66.21	98	108
28- 8M-85F	2F	16	28	71.30	98	108
30- 8M-85F	2F	16	30	76.40	98	108
32- 8M-85F	2F	16	32	81.49	98	108
34- 8M-85F	2F	16	34	86.58	98	108
36- 8M-85F	2F	16	36	91.68	98	108
38- 8M-85F	2F	16	38	96.77	98	108
40- 8M-85F	2F	16	40	101.86	98	108
44- 8M-85F	2F	16	44	112.05	98	108
48- 8M-85F	2F	16	48	122.23	98	108
56- 8M-85F	3F	16	56	142.61	98	108
64- 8M-85F	3F	16	64	162.98	98	108
72- 8M-85F	3F	16	72	183.35	98	108
80- 8M-85	4	20	80	203.72	98	108
90- 8M-85	4	20	90	229.19	98	108
112- 8M-85	5	20	112	285.21	98	108
144- 8M-85	5	20	144	366.70	98	108



PLOT TİP TRİGER DİŞLİLER

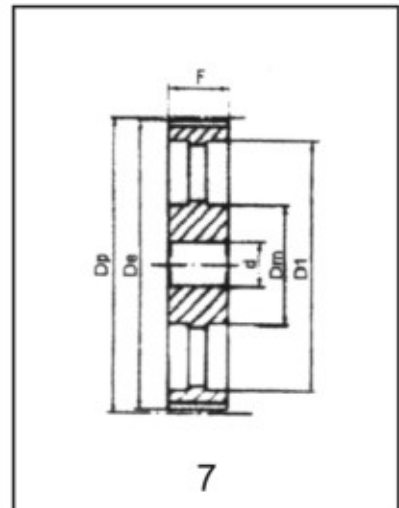
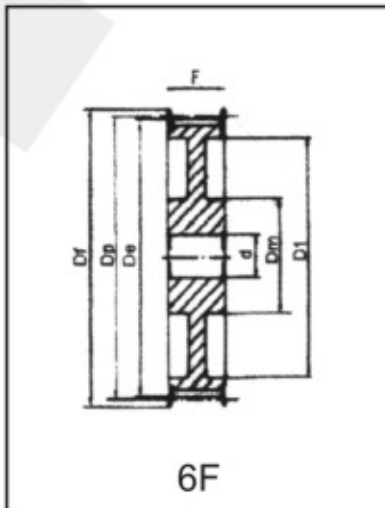
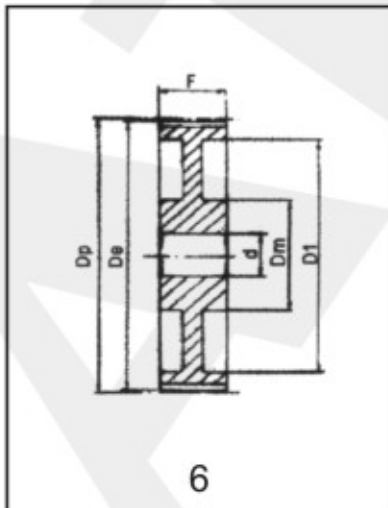
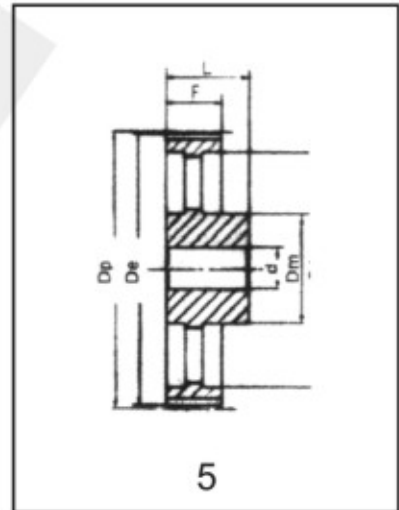
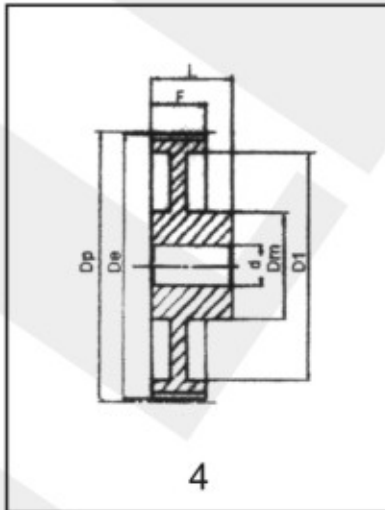
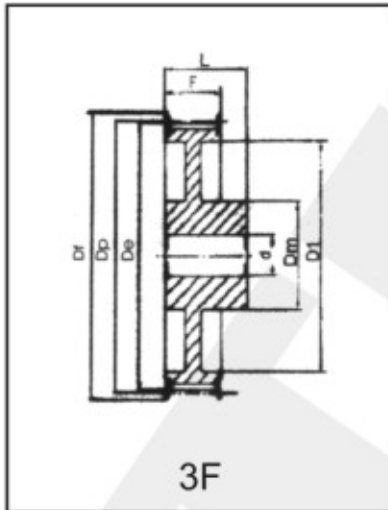
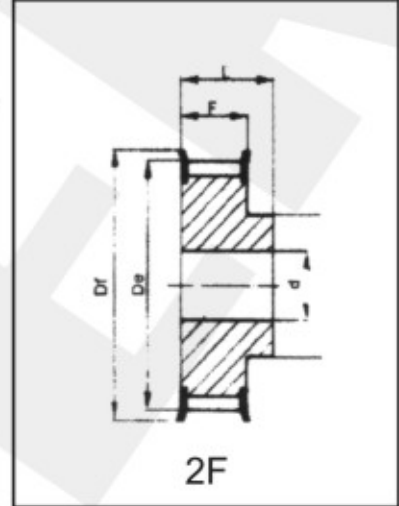
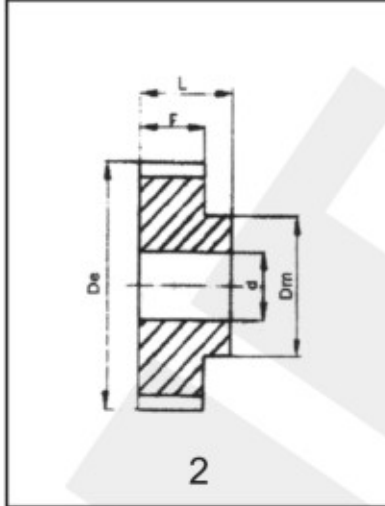
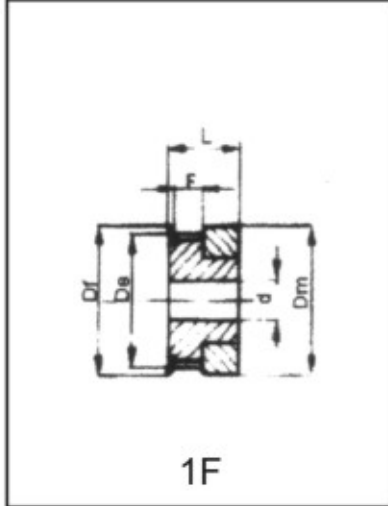



HTD TİP PLOT DELİKLİ TRİGER DİŞLİLER

HTD 14M (14 mm) ADIMLI TRİGER DİŞLİLER

HDT 14 M-40						
KOD CODE	TİP TYPE	d	Z	DP	F	L
28- 14M-40F	2F	24	28	124.78	54	69
29- 14M-40F	2F	24	29	129.24	54	69
30- 14M-40F	2F	24	30	133.69	54	69
32- 14M-40F	2F	24	32	142.61	54	69
34- 14M-40F	2F	24	34	151.52	54	69
36- 14M-40F	2F	24	36	160.43	54	69
38- 14M-40F	2F	24	38	169.35	54	69
40- 14M-40F	2F	24	40	178.26	54	69
48- 14M-40F	2F	28	48	213.91	54	69
56- 14M-40F	2F	28	56	249.56	54	69
64- 14M-40F	2F	28	64	285.21	54	69
72- 14M-40	5	28	72	320.87	54	69
80- 14M-40	5	28	80	356.52	54	69
90- 14M-40	5	28	90	401.08	54	69
112-14M-40	5	28	112	499.12	54	69
144 14M-40	5	28	144	641.73	54	69
168- 14M-40	5	28	168	748.69	54	69
192- 14M-40	5	28	192	855.64	54	69
212- 14M-40	5	30	212	944.77	54	69

HDT 14 M-55						
KOD CODE	TİP TYP E	d	Z	DP	F	L
28- 14M-55F	2F	24	28	124.78	70	85
29- 14M-55F	2F	24	29	129.24	70	85
30- 14M-55F	2F	24	30	133.69	70	85
32- 14M-55F	2F	24	32	142.61	70	85
34- 14M-55F	2F	24	34	151.52	70	85
36- 14M-55F	2F	24	36	160.43	70	85
38- 14M-55F	2F	24	38	169.35	70	85
40- 14M-55F	2F	24	40	178.26	70	85
48- 14M-55F	2F	28	48	213.91	70	85
56- 14M-55F	2F	28	56	249.56	70	85
64- 14M-55F	2F	28	64	285.21	70	85
72- 14M-55	7	28	72	320.87	70	85
80- 14M-55	7	28	80	356.52	70	85
90- 14M-55	7	28	90	401.08	70	85
112-14M-55	7	28	112	499.12	70	85
144 14M-55	7	28	144	641.73	70	85
168- 14M-55	7	28	168	748.69	70	85
192- 14M-55	7	28	192	855.64	70	85
212- 14M-55	7	30	212	944.77	70	85

HDT 14 M-85						
KOD CODE	TİP TYPE	d	Z	DP	F	L
28- 14M-85F	2F	24	28	124.78	102	117
29- 14M-85F	2F	24	29	129.24	102	117
30- 14M-85F	2F	24	30	133.69	102	117
32- 14M-85F	2F	24	32	142.61	102	117
34- 14M-85F	2F	32	34	151.52	102	117
36- 14M-85F	2F	32	36	160.43	102	117
38- 14M-85F	2F	32	38	169.35	102	117
40- 14M-85F	2F	32	40	178.26	102	117
48- 14M-85F	2F	32	48	213.91	102	117
56- 14M-85F	2F	32	56	249.56	102	117
64- 14M-85F	2F	32	64	285.21	102	117
72- 14M-85	7	32	72	320.87	102	117
80- 14M-85	7	32	80	356.52	102	117
90- 14M-85	7	32	90	401.08	102	117
112-14M-85	7	32	112	499.12	102	117
144 14M-85	7	32	144	641.73	102	117
168- 14M-85	7	32	168	748.69	102	117
192- 14M-85	7	32	192	855.64	102	117
212- 14M-85	7	36	212	944.77	102	117

HDT 14 M-115						
KOD CODE	TİP TYPE	d	Z	DP	F	L
28- 14M-115F	2F	32	28	124.78	133	148
29- 14M-115F	2F	32	29	129.24	133	148
30- 14M-115F	2F	32	30	133.69	133	148
32- 14M-115F	2F	32	32	142.61	133	148
34- 14M-115F	2F	32	34	151.52	133	148
36- 14M-115F	2F	32	36	160.43	133	148
38- 14M-115F	2F	32	38	169.35	133	148
40- 14M-115F	2F	32	40	178.26	133	148
48- 14M-115F	2F	32	48	213.91	133	148
56- 14M-115F	2F	32	56	249.56	133	148
64- 14M-115F	2F	32	64	285.21	133	148
72- 14M-115	7	32	72	320.87	133	148
80- 14M-115	7	32	80	356.52	133	148
90- 14M-115	7	32	90	401.08	133	148
112-14M-115	7	32	112	499.12	133	148
144 14M-115	7	32	144	641.73	133	148
168- 14M-115	7	32	168	748.69	133	148
192- 14M-115	7	32	192	855.64	133	148
212- 14M-115	7	36	212	944.77	133	148



BURÇLU TİP TRİGER DİŞLİLER

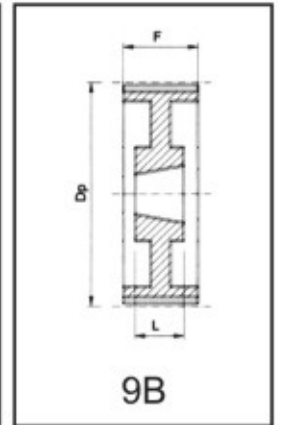
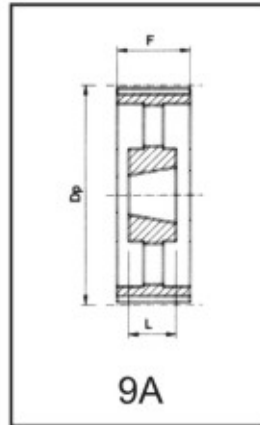
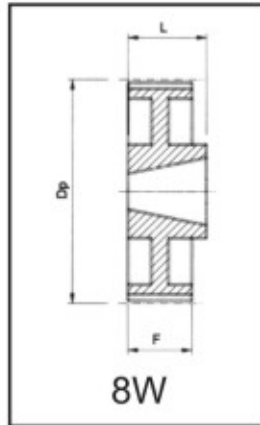
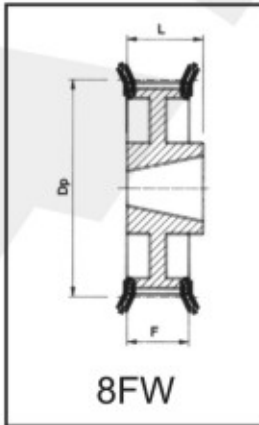
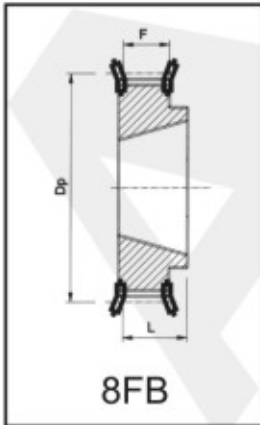
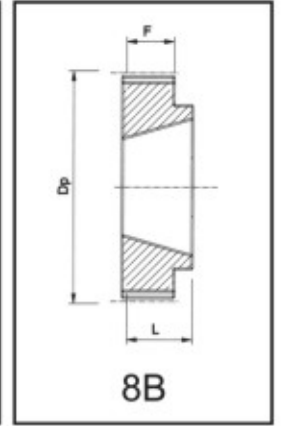
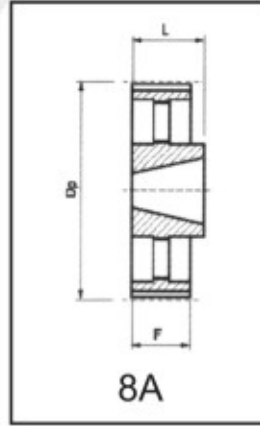
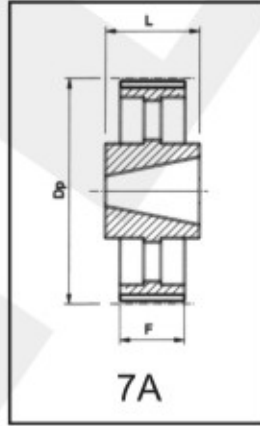
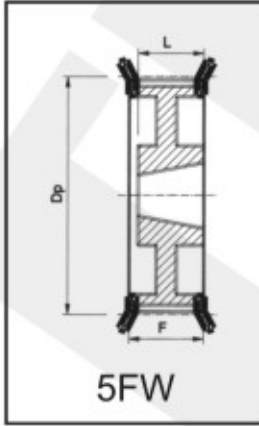
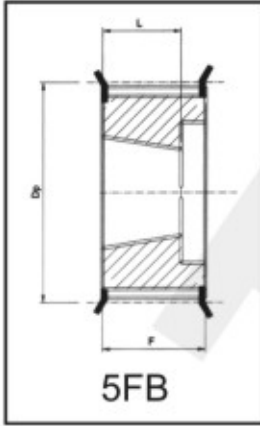
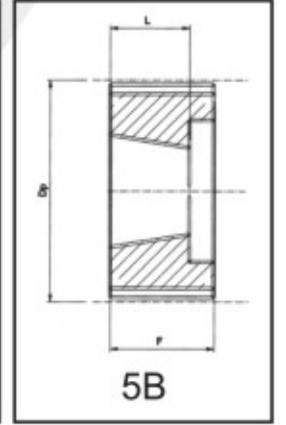
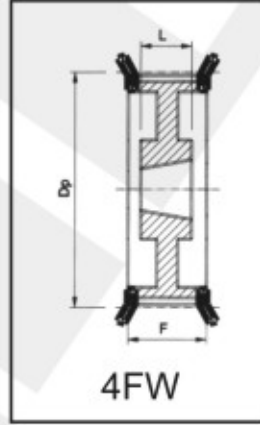
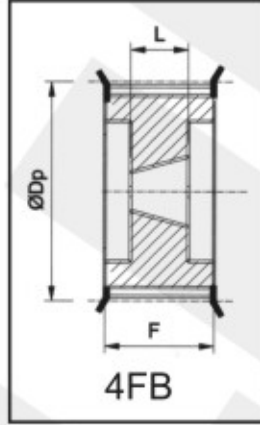
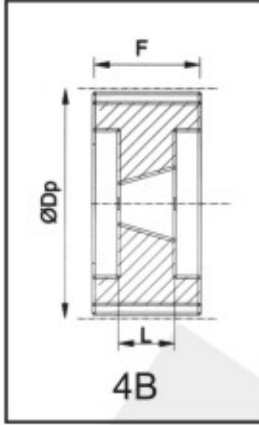
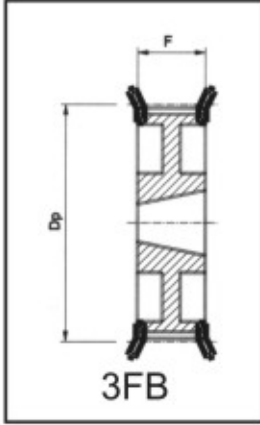
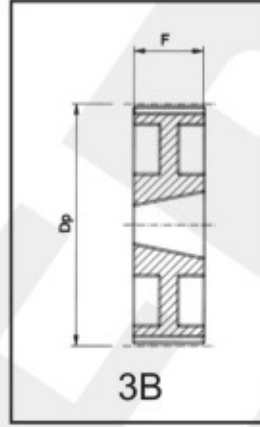
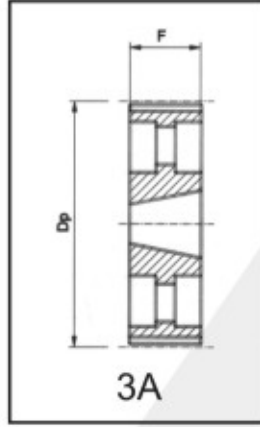
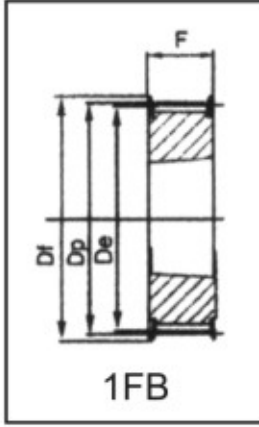



BURÇLU TRİGER DİŞLİLER

T5 ---- AT5 ADIMLI TRİGER DİŞLİLER

T5 B10						
KOD Code	TİP Type	BURÇ NO Taper bush	Z	DP	F	L
TB34- T5-B10F	4FB	1008	34	54.11	15	22
TB36- T5-B10F	4FB	1008	36	57.30	15	22
TB38- T5-B10F	4FB	1008	38	60.48	15	22
TB40- T5-B10F	4FB	1008	40	63.66	15	22
TB44- T5-B10F	4FB	1008	44	70.03	15	22
TB48 -T5-B10	4B	1210	48	76.40	15	25
TB56 - T5-B10	4B	1210	56	89.13	15	25
TB64- T5-B10	4B	1210	64	101.86	15	25
TB72- T5-B10	4B	1610	72	114.59	15	25
TB80- T5-B10	4B	1610	80	127.33	15	25
TB90- T5-B10	4B	1610	90	143.24	15	25
TB112- T5-B10	4B	1610	112	178.26	15	25
TB144- T5-B10	4B	2012	144	229.19	15	32

T5 B16						
KOD Code	TİP Type	BURÇ NO Taper bush	Z	DP	F	L
TB36- T5-B16F	4FB	1008	36	57.30	21	22
TB38- T5-B16F	4FB	1008	38	60.48	21	22
TB40- T5-B16F	4FB	1008	40	63.66	21	22
TB44- T5-B16F	4FB	1210	44	70.03	21	25
TB48 -T5-B16	4B	1210	48	76.40	21	25
TB56 - T5-B16	4B	1210	56	89.13	21	25
TB64- T5-B16	4B	1610	64	101.86	21	25
TB72- T5-B16	4B	1610	72	114.59	21	25
TB80- T5-B16	4B	2012	80	127.33	21	32
TB90- T5-B16	4B	2012	90	143.24	21	32
TB112- T5-B16	4B	2012	112	178.26	21	32
TB144- T5-B16	4B	2012	144	229.19	21	32

T5 B25						
KOD CODE	TİP TYPE	BURÇ NO TAPER BUSH	Z	DP	F	L
B36- T5-B25F	5FB	1108	36	57.30	30	22
B38- T5--B25F	5FB	1108	38	60.48	30	22
B40- T5--B25F	5FB	1108	40	63.66	30	22
B44- T5--B25F	5FB	1210	44	70.03	30	25
B48 -T5-B25	5B	1210	48	76.40	30	25
B56 - T5-B25	5B	1210	56	89.13	30	25
B64- T5-B25	5B	1610	64	101.86	30	25
B72- T5-B25	5B	1610	72	114.59	30	25
B80- T5-B25	5B	2012	80	127.33	30	32
B90- T5-B25	5B	2012	90	143.24	30	32
B112- T5-B25	5B	2012	112	178.26	30	32
B144- T5-B25	5B	2012	144	229.19	30	32



BURÇLU TİP TRİGER DİŞLİLER

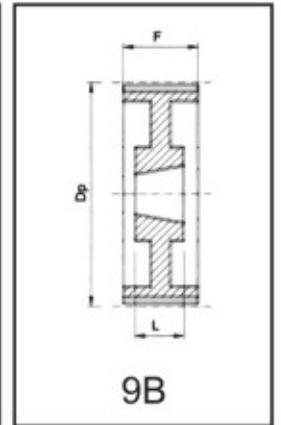
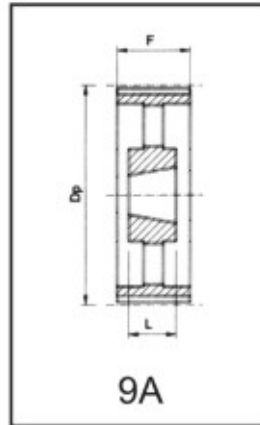
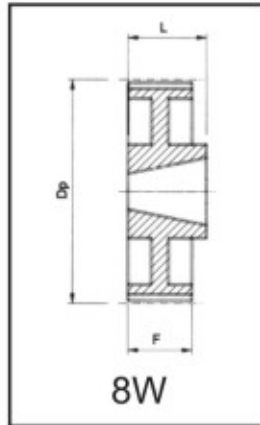
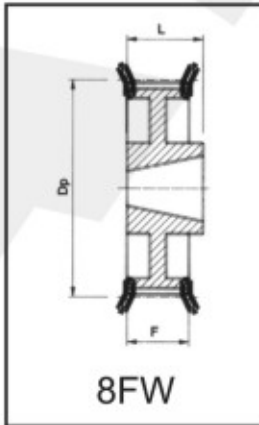
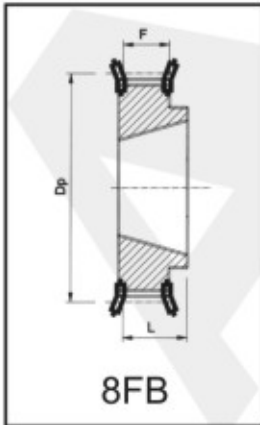
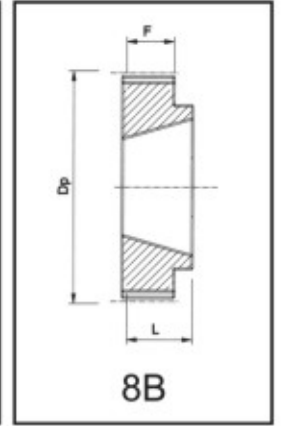
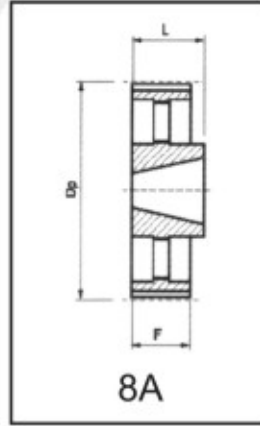
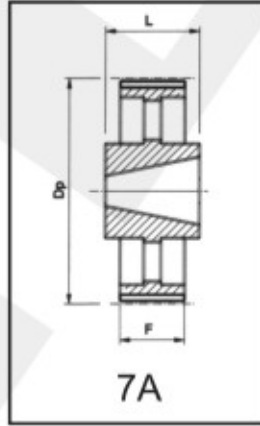
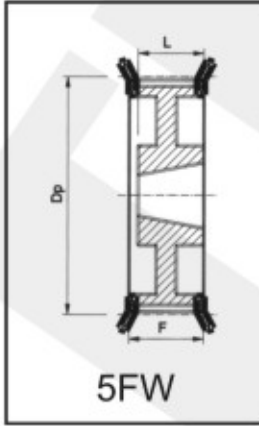
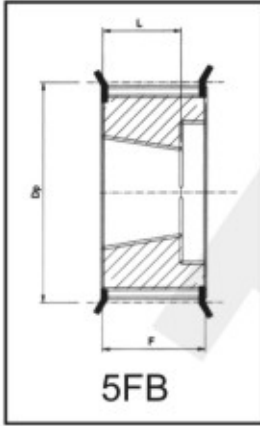
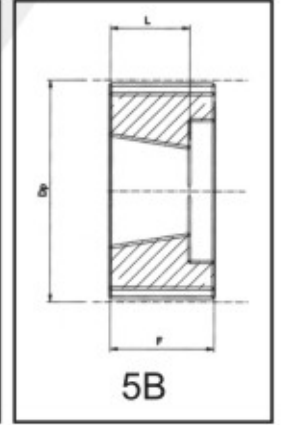
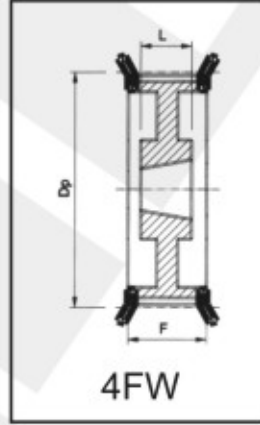
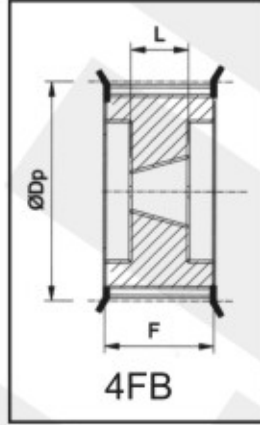
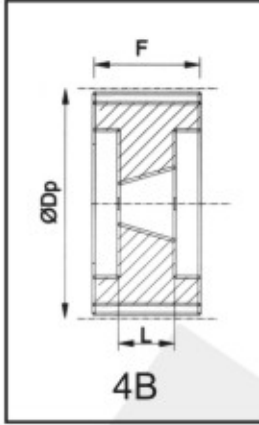
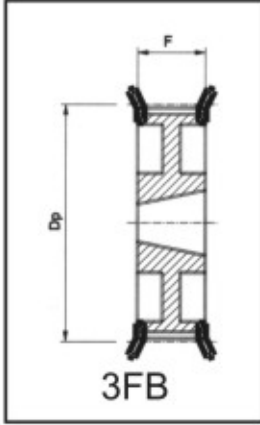
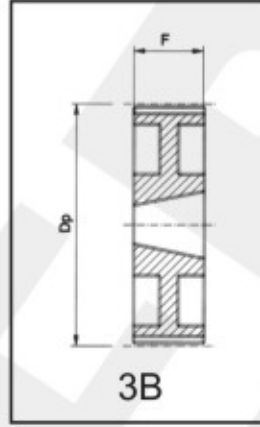
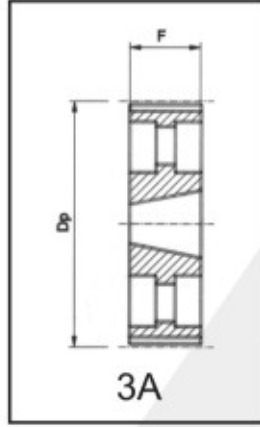
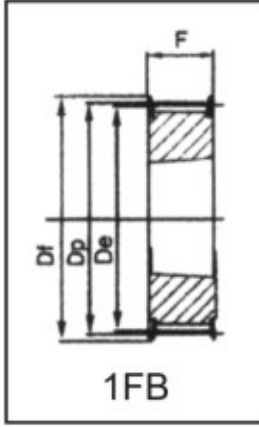



BURÇLU TRİGER DİŞLİLER

T10 ---- AT10 ADIMLI TRİGER DİŞLİLER

T10 B16						
KOD CODE	TİP TYPE	BURÇ NO TAPER BUSH	Z	DP	F	L
B18- T10 B16F	8FB	1210	18	57.30	21	25
B20- T10 B16F	8FB	1210	20	63.66	21	25
B22- T10 B16F	8FB	1210	22	70.03	21	25
B24- T10 B16F	8FB	1610	24	76.40	21	25
B26- T10 B16F	8FB	1610	26	82.76	21	25
B28- T10 B16F	8FB	1610	28	89.13	21	25
B30- T10 B16F	8FB	1610	30	95.50	21	25
B32- T10 B16F	8FB	1610	32	101.86	21	25
B36- T10 B16F	8FB	1610	36	114.59	21	25
B40- T10 B16F	8FB	1610	40	127.33	21	25
B44- T10 B16	8B	2012	44	140.06	21	32
B48- T10 B16	8W	2012	48	152.79	21	32
B60- T10 B16	8W	2012	60	190.99	21	32
B72- T10 B16	8W	2517	72	229.19	21	45
B80- T10 B16	8W	2517	80	254.66	21	45

T10 B25						
KOD CODE	TİP TYPE	BURÇ NO TAPER BUSH	Z	DP	F	L
B18- T10 B25F	4FB	1210	18	57.30	30	25
B20- T10 B25F	4FB	1210	20	63.66	30	25
B22- T10 B25F	4FB	1610	22	70.03	30	25
B24- T10 B25F	4FB	1610	24	76.40	30	25
B26- T10 B25F	4FB	1610	26	82.76	30	25
B28- T10 B25F	4FB	1610	28	89.13	30	25
B30- T10 B25F	4FB	1610	30	95.50	30	25
B32- T10 B25F	4FB	1610	32	101.86	30	25
B36- T10 B25F	4FB	1610	36	114.59	30	25
B40- T10 B25F	8FB	2012	40	127.33	30	32
B44- T10 B25	8B	2012	44	140.06	30	32
B48- T10 B25	8W	2012	48	152.79	30	32
B60- T10 B25	8W	2517	60	190.99	30	45
B72- T10 B25	8W	2517	72	229.19	30	45
B80- T10 B25	8W	2517	80	254.66	30	45

T10 B32						
KOD CODE	TİP TYPE	BURÇ NO TAPER BUSH	Z	DP	F	L
B18- T10 B32F	4FB	1210	18	57.30	37	25
B20- T10 B32F	4FB	1610	20	63.66	37	25
B22- T10 B32F	4FB	1610	22	70.03	37	25
B24- T10 B32F	4FB	1610	24	76.40	37	25
B26- T10 B32F	4FB	1610	26	82.76	37	25
B28- T10 B32F	4FB	1610	28	89.13	37	25
B30- T10 B32F	4FB	1610	30	95.50	37	25
B32- T10 B32F	4FB	1610	32	101.86	37	25
B36- T10 B32F	4FB	2012	36	114.59	37	25
B40- T10 B32F	4FB	2012	40	127.33	37	25
B44- T10 B32	4B	2012	44	140.06	37	32
B48- T10 B32	4B	2517	48	152.79	37	32
B60- T10 B32	4B	2517	60	190.99	37	32
B72- T10 B32	8B	2517	72	229.19	37	45
B80- T10 B32	8B	3020	80	254.66	37	51

T10 B50						
KOD CODE	TİP TYPE	BURÇ NO TAPER BUSH	Z	DP	F	L
B20- T10 B50F	4FB	1615	20	63.66	56	25
B22- T10 B50F	4FB	1615	22	70.03	56	25
B24- T10 B50F	4FB	1615	24	76.40	56	25
B26- T10 B50F	4FB	1615	26	82.76	56	25
B28- T10 B50F	4FB	1615	28	89.13	56	25
B30- T10 B50F	4FB	1615	30	95.50	56	25
B32- T10 B50F	4FB	1615	32	101.86	56	25
B36- T10 B50F	4FB	1615	36	114.59	56	25
B40- T10 B50F	4FB	2012	40	127.33	56	25
B44- T10 B50	4B	2517	44	140.06	56	32
B48- T10 B50	4B	2517	48	152.79	56	32
B60- T10 B50	4B	2517	60	190.99	56	45
B72- T10 B50	8B	3030	72	229.19	56	76
B80- T10 B50	8B	3030	80	254.66	56	76



BURÇLU TİP TRİGER DİŞLİLER

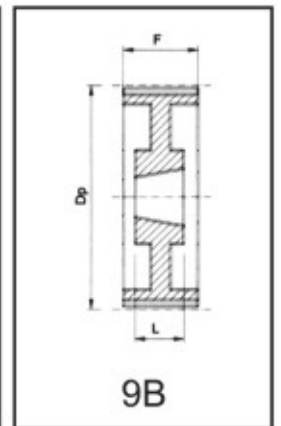
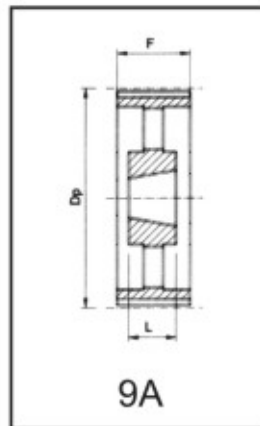
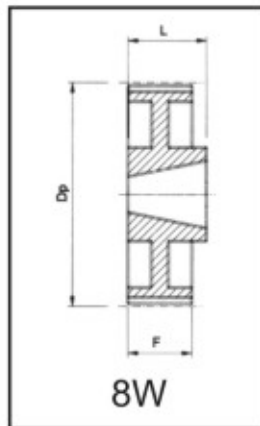
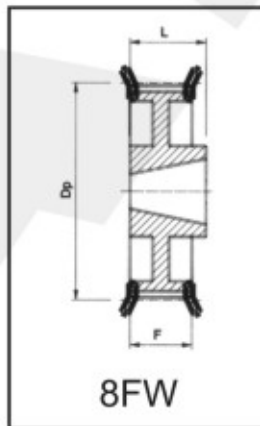
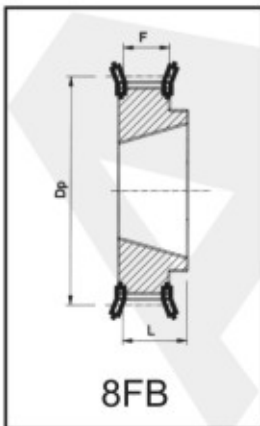
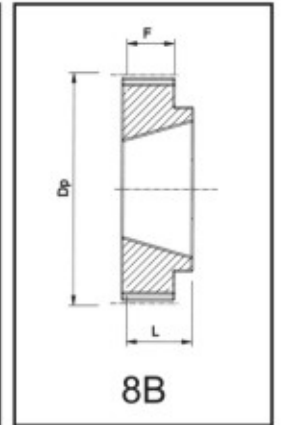
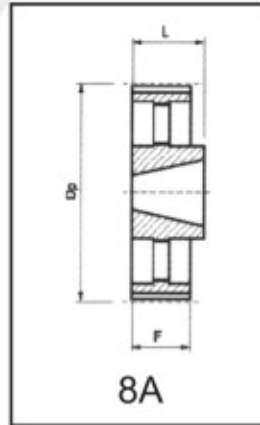
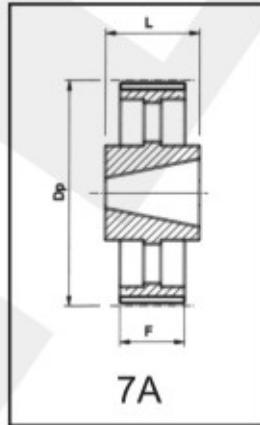
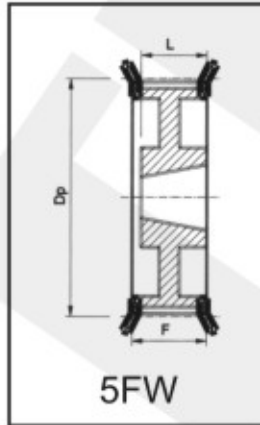
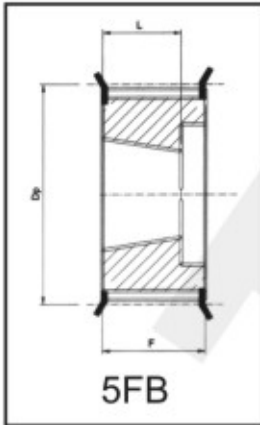
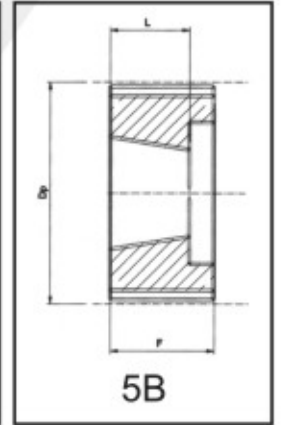
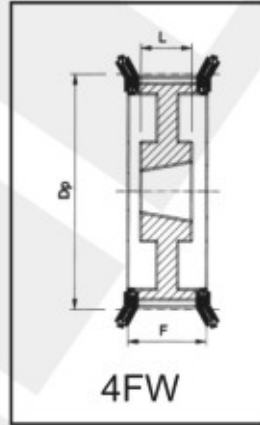
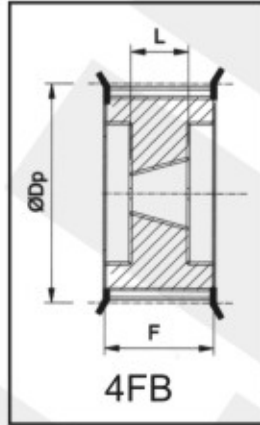
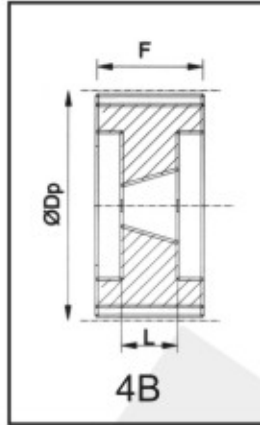
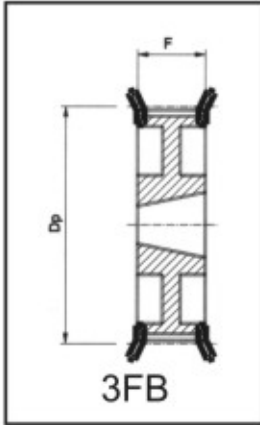
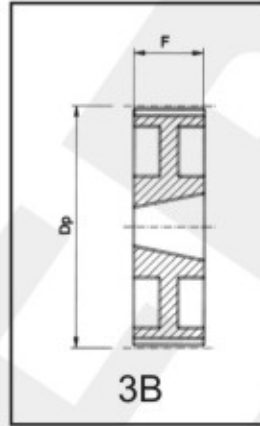
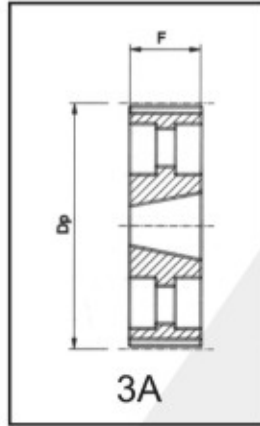
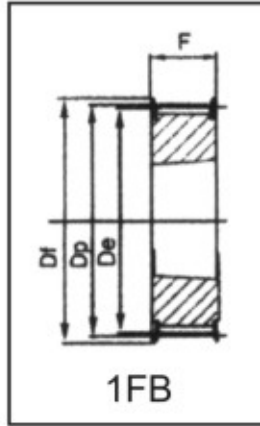



BURÇLU TRİGER DİŞLİLER

XL (5,08mm) ADIMLI TRİGER DİŞLİLER

XL037						
KOD CODE	TİP TYPE	BURÇ NO TAPER BUSH	Z	DP	F	L
B34- XL037F	4FB	1008	34	54,11	22	22
B36- XL037F	5FB	1108	36	57,30	22	22
B38- XL037F	5FB	1108	38	60,48	22	22
B40- XL037F	5FB	1108	40	63,66	22	22
B44- XL037F	5FB	1108	44	70,03	22	22
B48- XL037F	5FB	1210	48	76,40	22	25
B56- XL037	4B	1210	56	89,13	22	25
B64- XL037	4B	1210	64	101,86	22	25
B72- XL037	4B	1610	72	114,59	22	25
B80- XL037	4B	1610	80	127,33	22	25
B90- XL037	4B	1610	90	143,24	22	25
B112- XL037	4B	1610	112	178,26	22	25
B144- XL037F	4B	2012	144	229,19	22	32



BURÇLU TİP TRİGER DİŞLİLER

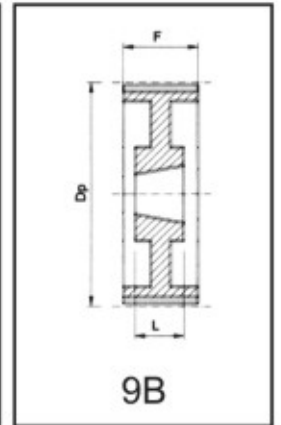
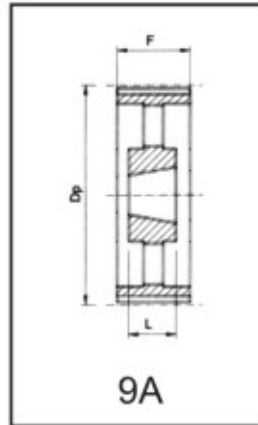
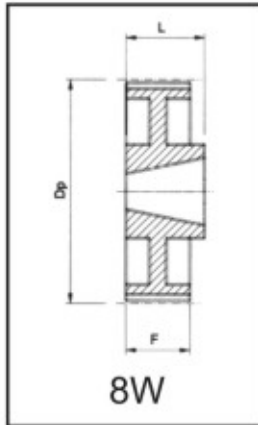
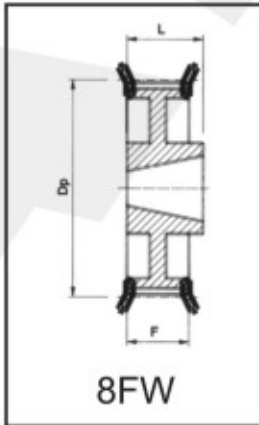
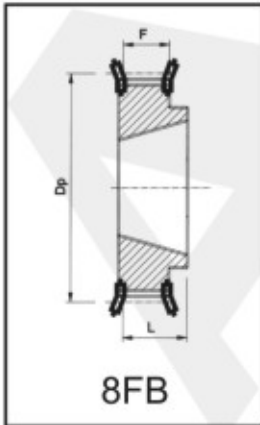
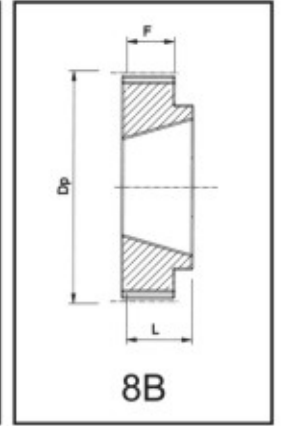
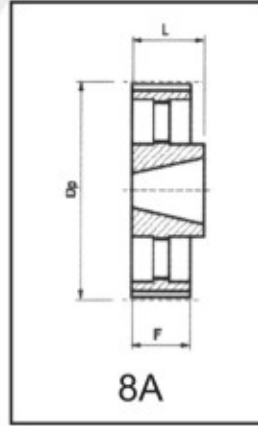
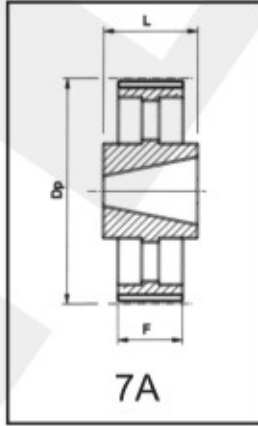
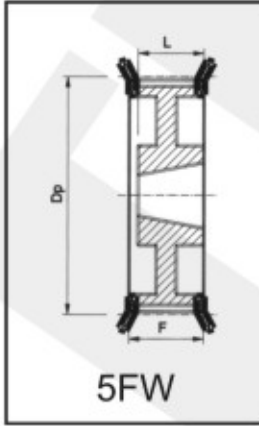
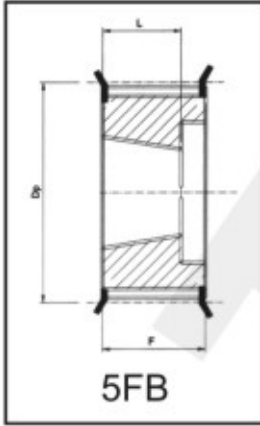
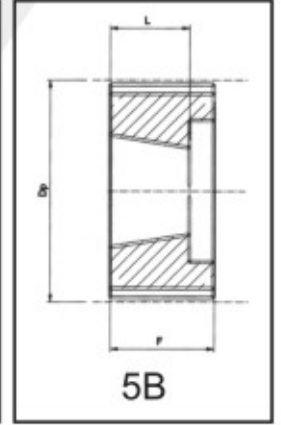
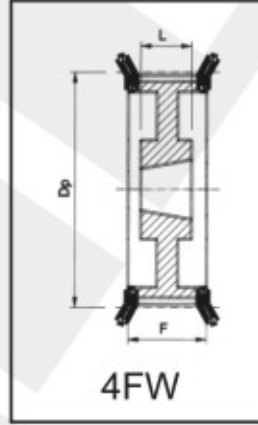
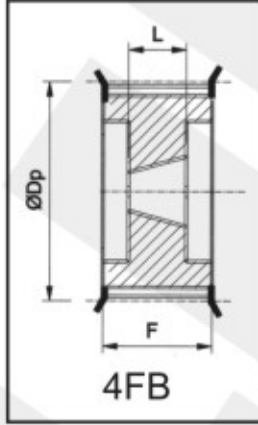
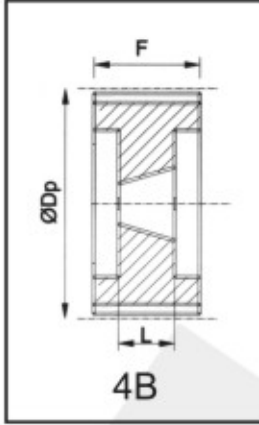
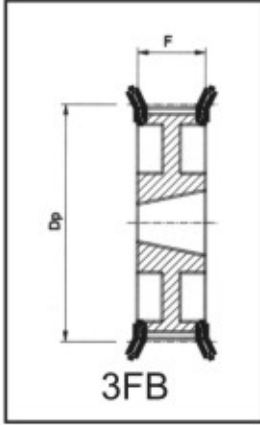
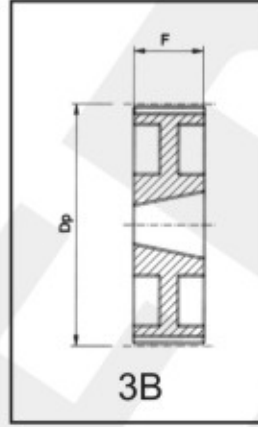
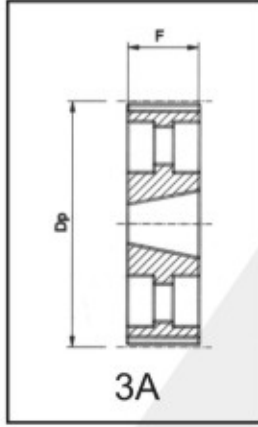
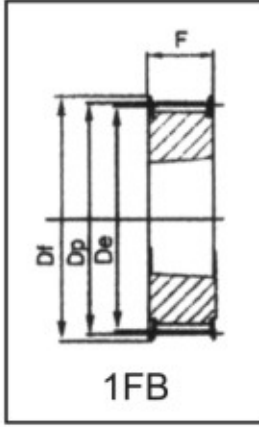



BURÇLU TRİGER DİŞLİLER

L (9,525mm) ADIMLI TRİGER DİŞLİLER

L075						
KOD CODE	TIP TYPE	BURÇ NO TAPER BUSH	Z	DP	F	L
B18- L075 F	5FB	1108	18	54.58	25	25
B20- L075 F	5FB	1108	20	60.64	25	25
B22- L075 F	5FB	1108	22	66.70	25	25
B24- L075 F	5FB	1108	24	72.77	25	25
B25- L075 F	5FB	1108	25	75.80	25	25
B26- L075 F	5FB	1108	26	78.83	25	25
B28- L075 F	5FB	1108	28	84.90	25	25
B30- L075 F	5FB	1108	30	90.96	25	25
B32- L075 F	5FB	1108	32	97.02	25	22
B36- L075 F	5FB	1210	36	109.15	25	25
B40- L075 F	5FB	1210	40	121.28	25	25
B44- L075 F	3FB	1610	44	133.41	25	25
B48- L075 F	3FB	1610	48	145.54	25	25
B60- L075	3B	1610	60	181.92	25	25
B72- L075	3A	1610	72	218.30	25	25
B80- L075	7A	2012	80	242.56	25	32
B90- L075	7A	2012	90	272.88	25	32
B112- L075	7A	2012	112	339.58	25	32
B144- L075	7A	2012	144	436.61	25	32

L100						
KOD CODE	TIP TYPE	BURÇ NO TAPER BUSH	Z	DP	F	L
B18- L100 F	5FB	1108	18	54.58	31	22
B20- L100 F	5FB	1108	20	60.64	31	22
B22- L100 F	5FB	1108	22	66.70	31	22
B24- L100 F	5FB	1108	24	72.77	31	22
B25- L100 F	5FB	1108	25	75.80	31	22
B26- L100 F	5FB	1108	26	78.83	31	22
B28- L100 F	5FB	1108	28	84.90	31	22
B30- L100 F	5FB	1210	30	90.96	31	25
B32- L100 F	5FB	1210	32	97.02	31	25
B36- L100 F	5FB	1210	36	109.15	31	25
B40- L100 F	5FB	1610	40	121.28	31	25
B44- L100 F	5FW	1610	44	133.41	31	25
B48- L100 F	5FW	1610	48	145.54	31	25
B60- L100	5FW	1610	60	181.92	31	25
B72- L100	3A	2012	72	218.30	31	32
B80- L100	3A	2012	80	242.56	31	32
B90- L100	3A	2012	90	272.88	31	32
B112- L100	3A	2012	112	339.58	31	32
B144- L100	7A	2517	144	436.61	31	45



BURÇLU TİP TRİGER DİŞLİLER

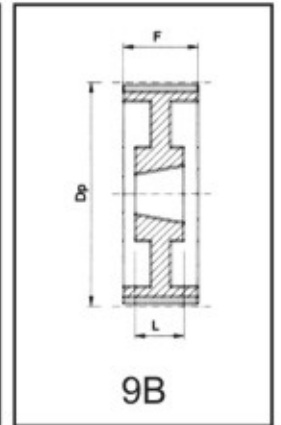
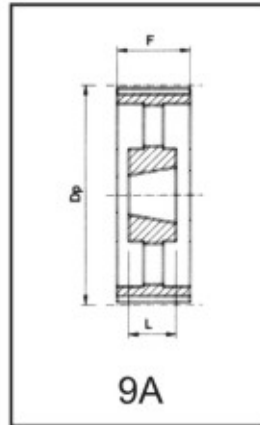
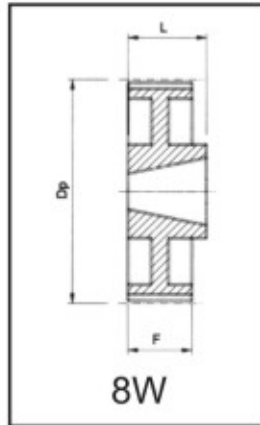
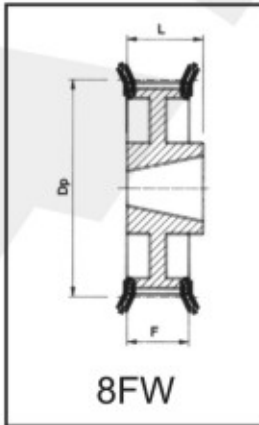
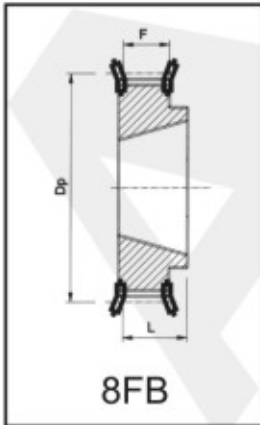
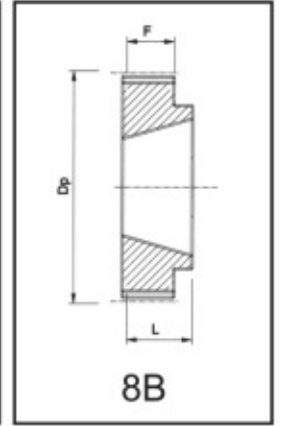
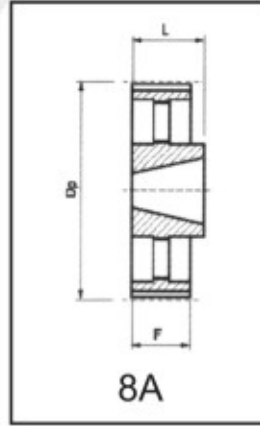
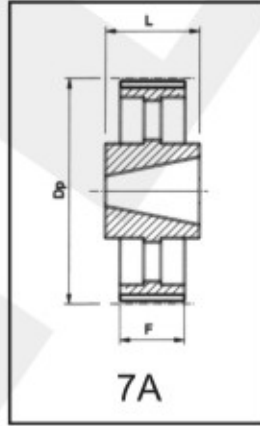
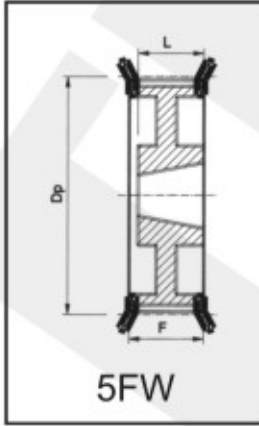
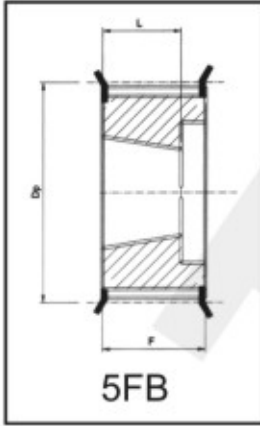
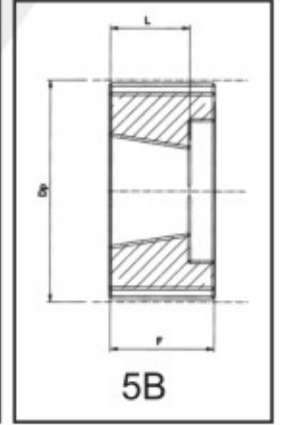
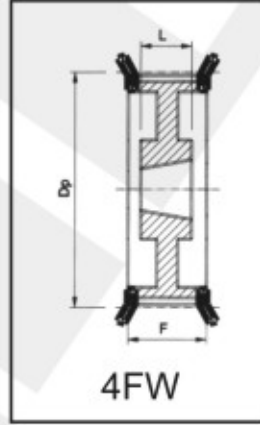
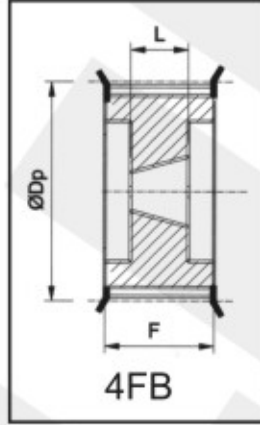
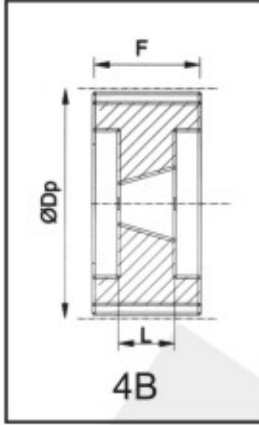
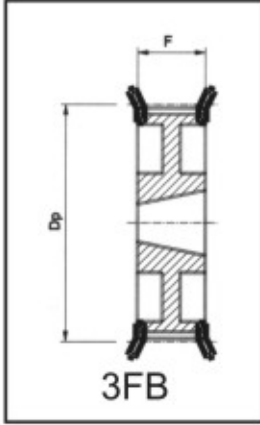
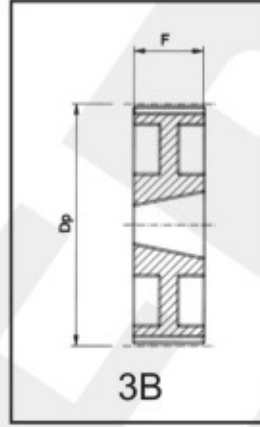
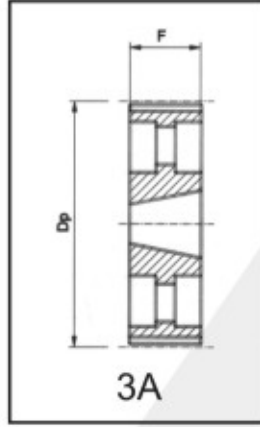
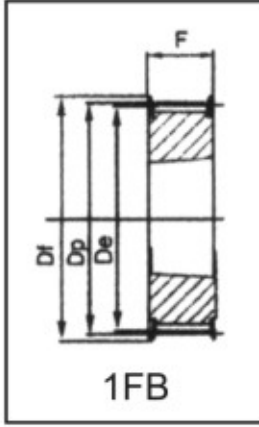



BURÇLU TRİGER DİŞLİLER

H (12,7mm) ADIMLI TRİGER DİŞLİLER

H100						
KOD CODE	TİP TYPE	BURÇ NO TAPER BUSH	Z	DP	F	L
B16- H100 F	5FB	1108	16	64.68	31	22
B18- H100 F	5FB	1210	18	72.77	31	25
B20- H100 F	5FB	1210	20	80.85	31	25
B22- H100 F	5FB	1210	22	88.94	31	25
B24- H100 F	5FB	1610	24	97.02	31	25
B25- H100 F	5FB	1610	25	101.07	31	25
B26- H100 F	5FB	1610	26	105.11	31	25
B28- H100 F	5FB	1610	28	113.19	31	25
B30- H100 F	5FB	1610	30	121.28	31	25
B32- H100 F	5 FW	1610	32	129.36	31	25
B36- H100 F	5 FW	1610	36	145.54	31	25
B40- H100 F	5 FW	1610	40	161.71	31	25
B44- H100 F	3FB	2012	44	177.88	31	32
B48- H100 F	3FB	2012	48	194.05	31	32
B60- H100	9A	2012	60	242.56	31	32
B72-H100	9A	2012	72	291.07	31	32
B80-H100	9A	2012	80	323.41	31	32
B90- H100	7A	2517	90	363.84	31	45
B112- H100	7A	2517	112	452.78	31	45
B144- H100	7A	2517	144	582.14	31	45

H150						
KOD CODE	TİP TYPE	BURÇ NO TAPER BUSH	Z	DP	F	L
B16- H150 F	5FB	1108	16	64.68	45	22
B18- H150 F	5FB	1210	18	72.77	45	25
B20- H150 F	5FB	1210	20	80.85	45	25
B22- H150 F	5FB	1210	22	88.94	45	25
B24- H150 F	5FB	1610	24	97.02	45	25
B25- H150 F	5FB	1610	25	101.07	45	25
B26- H150 F	5FB	1610	26	105.11	45	25
B28- H150 F	5FB	1610	28	113.19	45	25
B30- H150 F	5FB	1610	30	121.28	45	25
B32- H150 F	5 FW	1610	32	129.36	45	25
B36- H150 F	5 FW	1610	36	145.54	45	25
B40- H150 F	5 FW	1610	40	161.71	45	25
B44- H150 F	5 FW	2012	44	177.88	45	32
B48- H150 F	5 FW	2012	48	194.05	45	32
B60- H150	9A	2012	60	242.56	45	32
B72-H150	9A	2012	72	291.07	45	32
B80-H150	9A	2012	80	323.41	45	32
B90- H150	9A	2517	90	363.84	45	45
B112- H150	9A	2517	112	452.78	45	45
B144- H150	9A	2517	144	582.14	45	45

H200						
KOD CODE	TİP TYPE	BURÇ NO TAPER BUSH	Z	DP	F	L
B18- H200 F	5FB	1210	18	72.77	58	25
B20- H200 F	5FB	1210	20	80.85	58	25
B22- H200 F	5FB	1610	22	88.94	58	25
B24- H200 F	5FB	1610	24	97.02	58	25
B25- H200 F	5FB	1610	25	101.07	58	25
B26- H200 F	5FB	1610	26	105.11	58	25
B28- H200 F	5FB	1610	28	113.19	58	25
B30- H200 F	5FB	1610	30	121.28	58	25
B32- H200 F	5FB	2012	32	129.36	58	32
B36- H200 F	5 FW	2012	36	145.54	58	32
B40- H200 F	5 FW	2012	40	161.71	58	32
B44- H200 F	5 FW	2012	44	177.88	58	32
B48- H200 F	5 FW	2517	48	194.05	58	45
B60- H200	9A	2517	60	242.56	58	45
B72-H200	9A	2517	72	291.07	58	45
B80-H200	9A	2517	80	323.41	58	45
B90- H200	9A	2517	90	363.84	58	45
B112- H200	9A	2517	112	452.78	58	45
B144- H200	9A	3020	144	582.14	58	51



BURÇLU TİP TRİGER DİŞLİLER

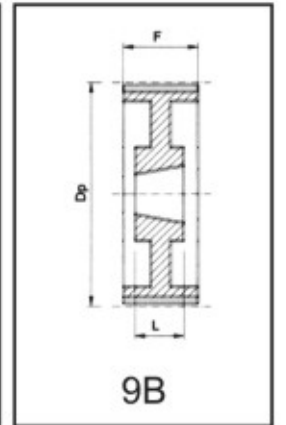
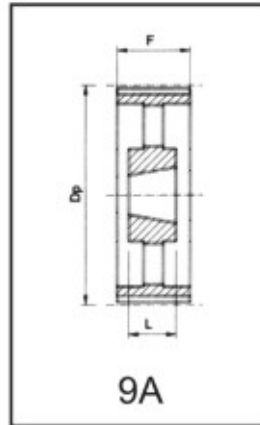
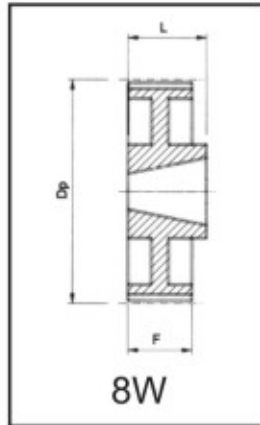
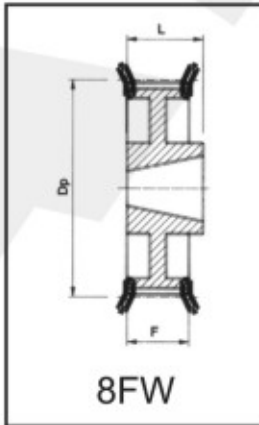
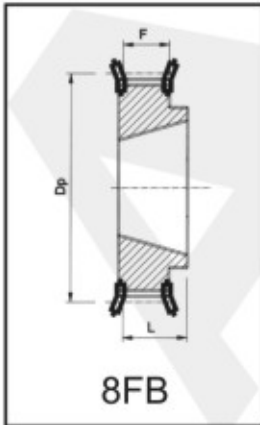
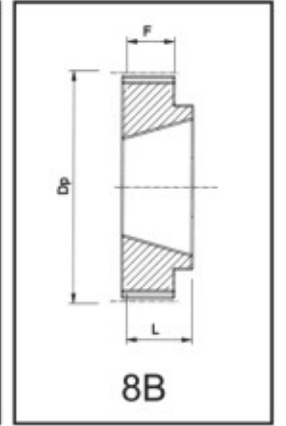
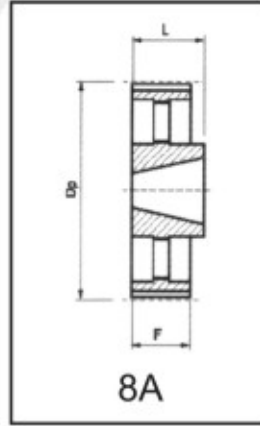
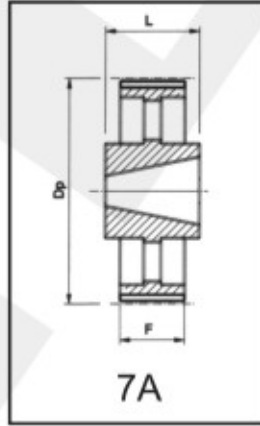
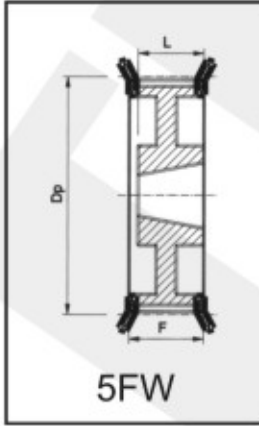
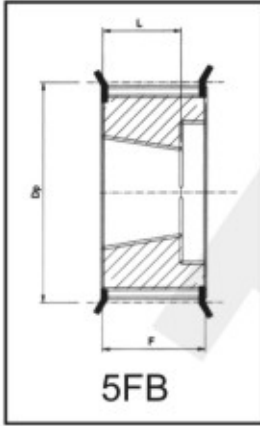
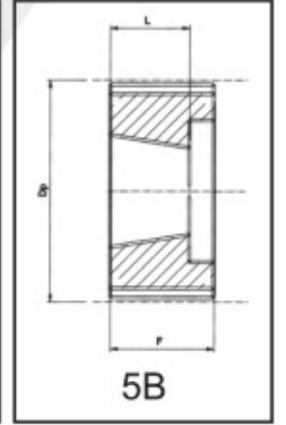
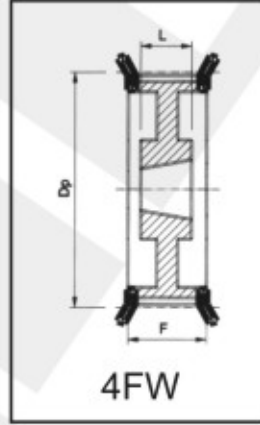
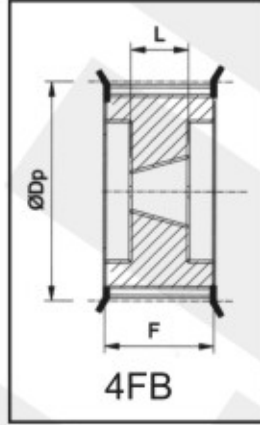
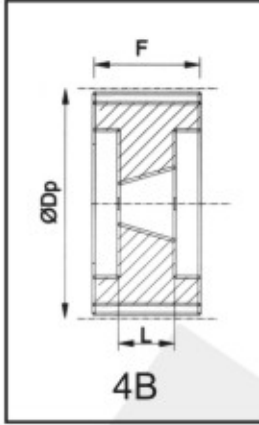
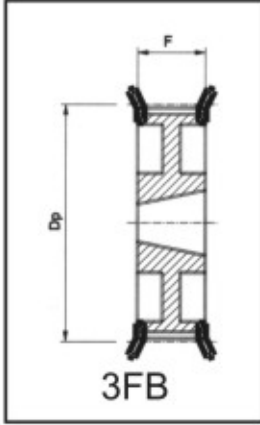
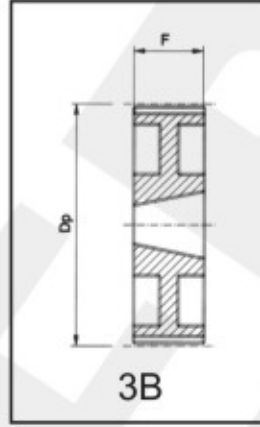
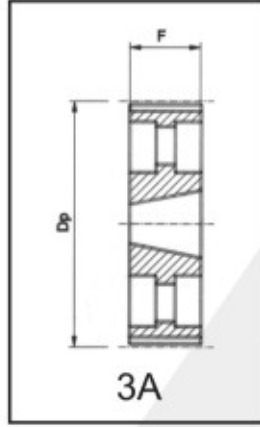
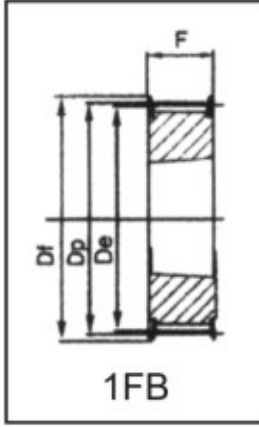



HTD TİP BURÇLU TRİGER DİŞLİLER

HTD 5M (5 mm) ADIMLI TRİGER DİŞLİLER

HTD 5M-15						
KOD CODE	TİP TYPE	BURÇ NO TAPER BUSH	Z	DP	F	L
B34- 5M-15F	4FB	1008	34	54.11	22	22
B36- 5M-15F	5FB	1108	36	57.30	22	22
B38-5M-15F	5FB	1108	38	60.48	22	22
B40- 5M-15F	5FB	1108	40	63.66	22	22
B44- 5M-15F	5FB	1108	44	70.03	22	22
B48- 5M-15F	5FB	1210	48	76.40	22	25
B56- 5M-15F	4FB	1210	56	89.13	22	25
B64- 5M-15F	4FB	1210	64	101.86	22	25
B72- 5M-15F	4FB	1610	72	114.59	22	25
B80- 5M-15F	4FB	1610	80	127.33	22	25
B90- 5M-15F	4FB	1610	90	143.24	22	25
B112- 5M-15F	5FW	1610	112	178.26	22	25
B144-5M-15	4B	2012	144	229.19	22	32

HTD 5M-25						
KOD CODE	TİP TYPE	BURÇ NO TAPER BUSH	Z	DP	F	L
B36- 5M-25F	5FB	1108	36	57.30	32	22
B38-5M-25F	5FB	1108	38	60.48	32	22
B40- 5M-25F	5FB	1108	40	63.66	32	22
B44- 5M-25F	5FB	1210	44	70.03	32	22
B48- 5M-25F	5FB	1210	48	76.40	32	25
B56- 5M-25F	4FB	1210	56	89.13	32	25
B64- 5M-25F	4FB	1610	64	101.86	32	25
B72- 5M-25F	4FB	1610	72	114.59	32	25
B80- 5M-25F	4FB	2012	80	127.33	32	32
B90- 5M-25F	4FB	2012	90	143.24	32	32
B112- 5M-25F	5FW	2012	112	178.26	32	32
B144-5M-25	4B	2012	144	229.19	32	32



BURÇLU TİP TRİGER DİŞLİLER

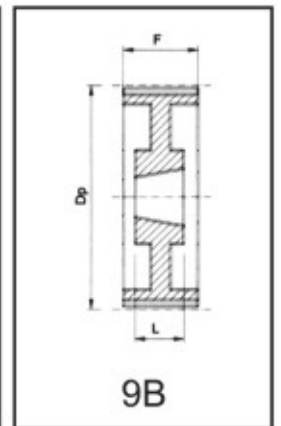
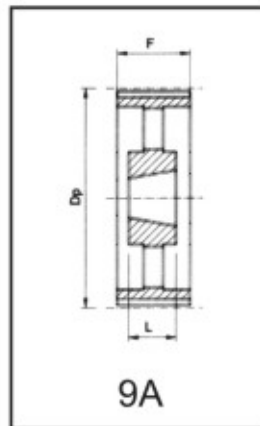
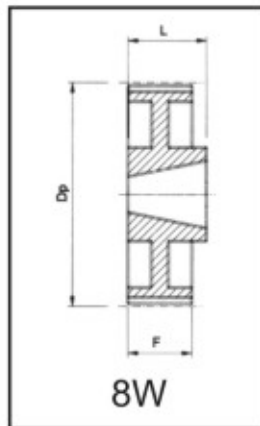
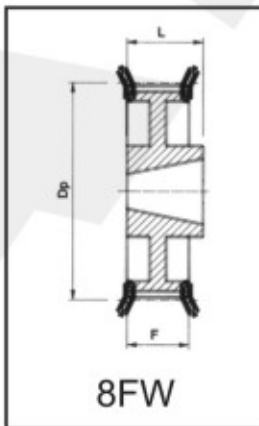
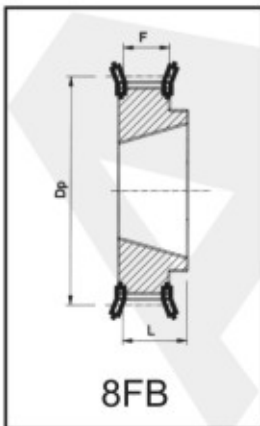
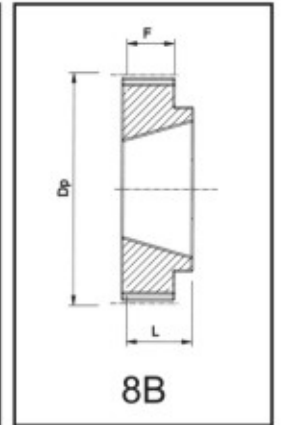
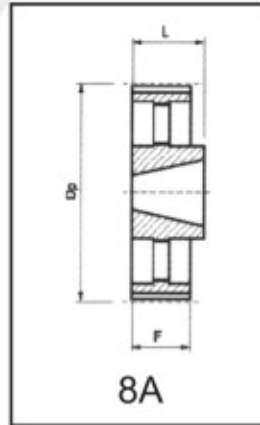
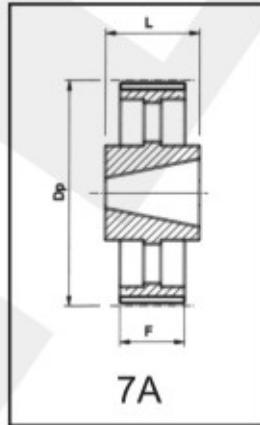
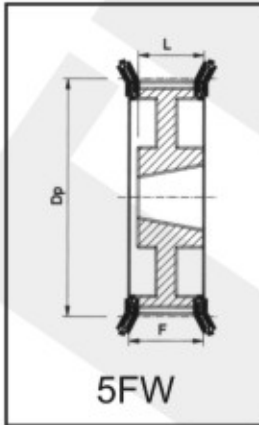
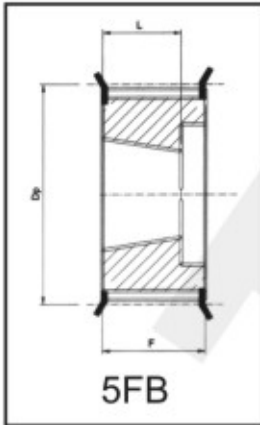
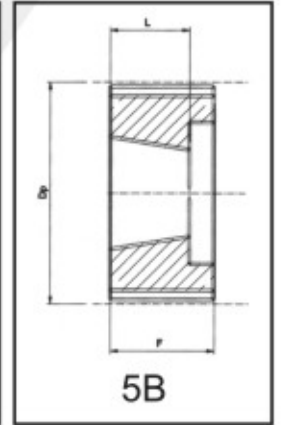
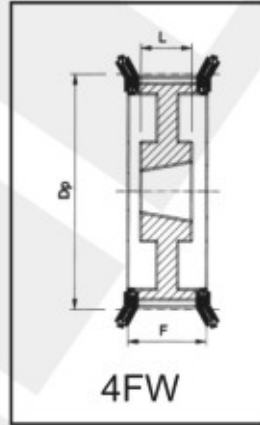
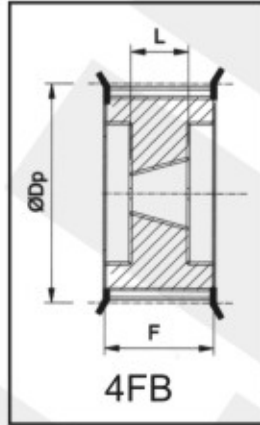
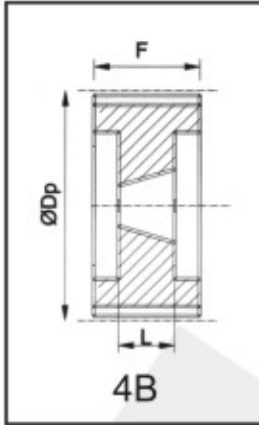
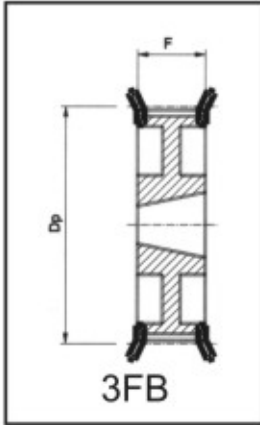
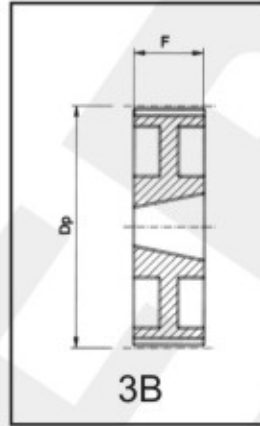
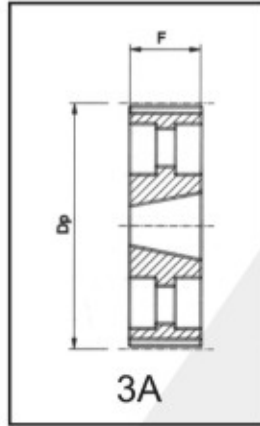
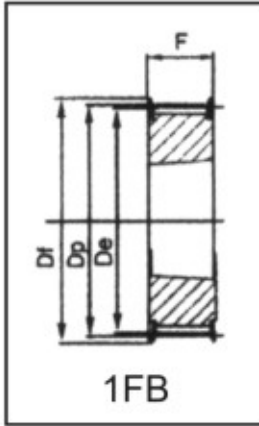



HTD TİP BURÇLU TRİGER DİŞLİLER

HTD 8M (8 mm) ADIMLI TRİGER DİŞLİLER

HTD 8M-30						
KOD CODE	TİP TYPE	BURÇ NO TAPER BUSH	Z	DP	F	L
B24- 8M-30F	5FB	1108	24	61.12	38	22
B26- 8M-30F	5FB	1108	26	66.21	38	22
B28- 8M-30F	5FB	1108	28	71.30	38	22
B30- 8M-30F	1FB	1615	30	76.40	38	38
B32- 8M-30F	1FB	1615	32	81.49	38	38
B34- 8M-30F	1FB	1615	34	86.58	38	38
B36- 8M-30F	1FB	1615	36	91.68	38	38
B38- 8M-30F	1FB	1615	38	96.77	38	38
B40- 8M-30F	1FB	1615	40	101.86	38	38
B44- 8M-30F	1FB	2012	44	112.05	38	32
B48- 8M-30F	4FB	2012	48	122.23	38	32
B56- 8M-30F	4FB	2012	56	142.61	38	32
B64- 8M-30F	8FW	2517	64	162.98	38	45
B72- 8M-30F	8FW	2517	72	183.35	38	45
B80- 8M-30	8FW	2517	80	203.72	38	45
B90- 8M-30	8W	2517	90	229.19	38	45
B112- 8M-30	8A	2517	112	285.21	38	45
B144- 8M-30	8A	2517	144	366.70	38	45



BURÇLU TIP TRİGER DİŞLİLER

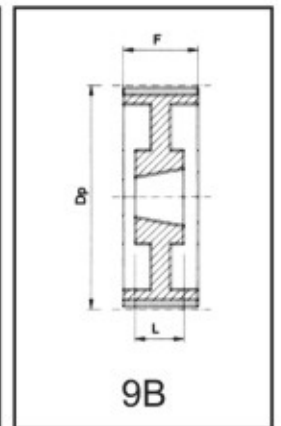
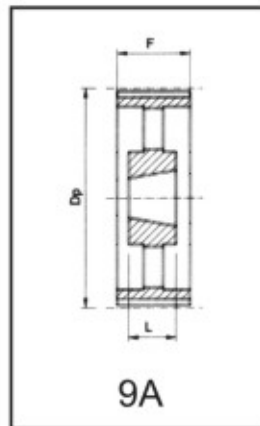
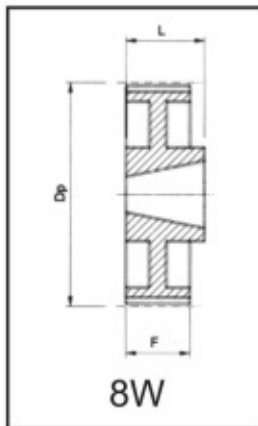
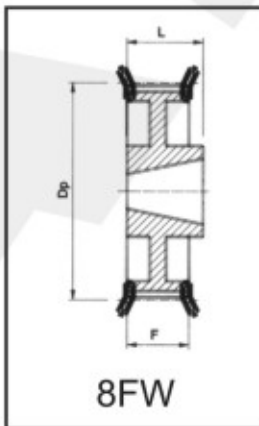
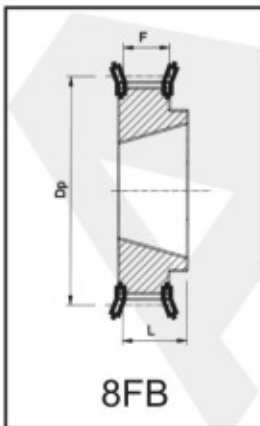
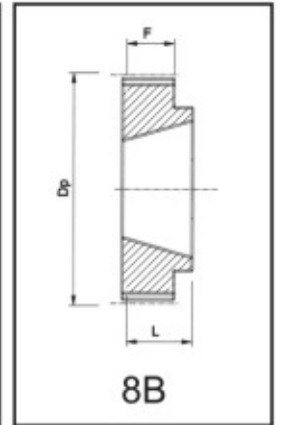
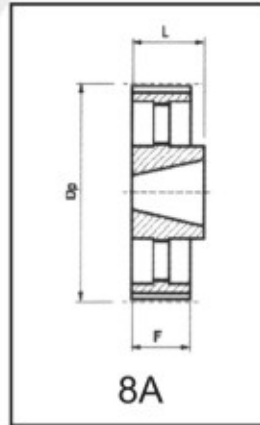
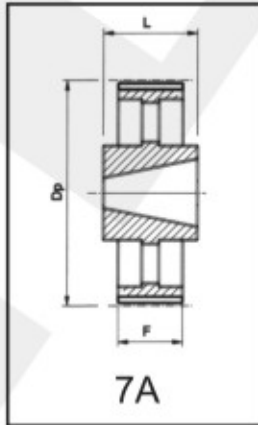
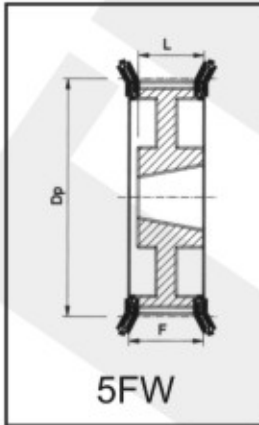
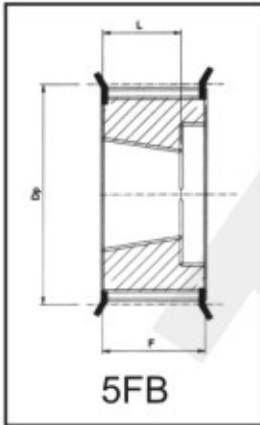
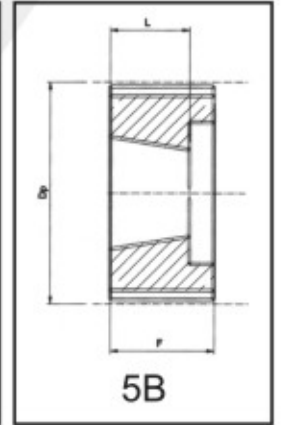
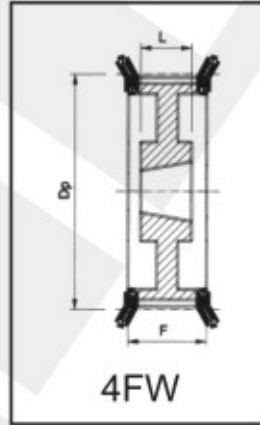
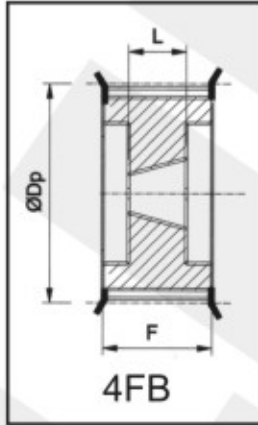
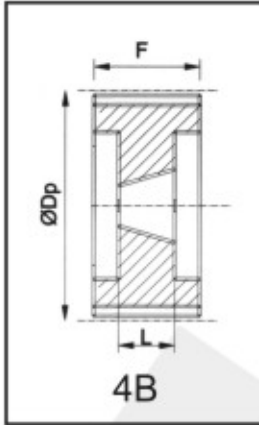
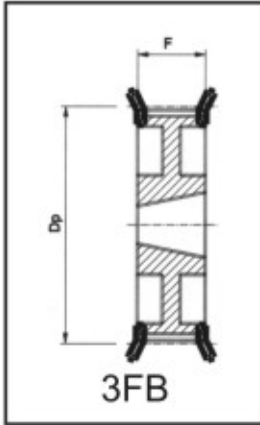
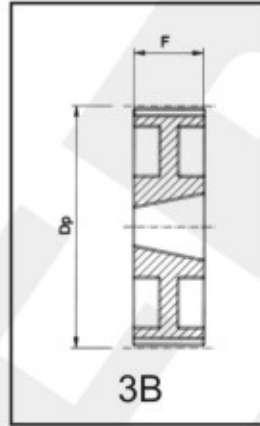
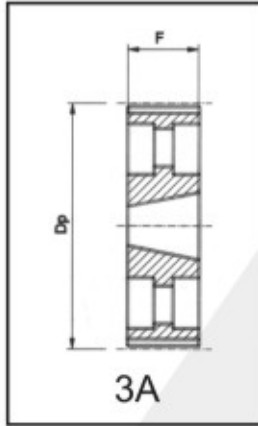
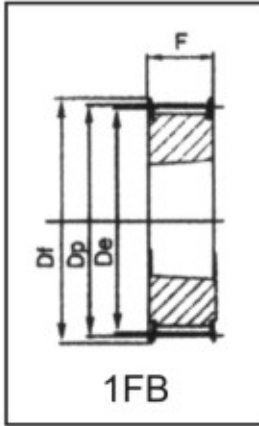



HTD TİP BURÇLU TRİGER DİŞLİLER

HTD 14M (14 mm) ADIMLI TRİGER DİŞLİLER

HDT 14 M-85						
KOD CODE	TİP TYPE	BURÇ NO TAPER BUSH	Z	DP	F	L
B28- 14M-85F	4FB	2517	28	124.78	102	42
B29- 14M-85F	4FB	2517	29	129.24	102	42
B30- 14M-85F	4FB	2517	30	133.69	102	42
B32- 14M-85F	4FB	2517	32	142.61	102	42
B34- 14M-85F	4FB	2517	34	151.52	102	42
B36- 14M-85F	4FB	3020	36	160.43	102	51
B38- 14M-85F	4FB	3020	38	169.35	102	51
B40- 14M-85F	4FB	3020	40	178.26	102	51
B48- 14M-85F	4FB	3030	48	213.91	102	76
B56- 14M-85F	4FB	3535	56	249.56	102	89
B64- 14M-85F	5FW	3535	64	285.21	102	89
B72- 14M-85	9A	3535	72	320.87	102	89
B80- 14M-85	9A	3535	80	356.52	102	89
B90- 14M-85	9A	3535	90	401.08	102	89
B112-14M-85	9A	3535	112	499.12	102	89
B144 14M-85	9A	3535	144	641.73	102	89
B168- 14M-85	9A	3535	168	748.69	102	89
B192- 14M-85	9A	4040	192	855.64	102	102
B212- 14M-85	9A	4040	212	944.77	102	102

HDT 14 M-115						
KOD CODE	TİP TYPE	BURÇ NO TAPER BUSH	Z	DP	F	L
B28- 14M-115F	4FB	2517	28	124.78	133	42
B29- 14M-115F	4FB	2517	29	129.24	133	42
B30- 14M-115F	4FB	2517	30	133.69	133	42
B32- 14M-115F	4FB	2517	32	142.61	133	42
B34- 14M-115F	4FB	2517	34	151.52	133	42
B36- 14M-115F	4FB	3020	36	160.43	133	51
B38- 14M-115F	4FB	3020	38	169.35	133	51
B40- 14M-115F	4FB	3020	40	178.26	133	51
B48- 14M-115F	4FB	3030	48	213.91	133	76
B56- 14M-115F	4FB	3535	56	249.56	133	89
B64- 14M-115F	5FW	3535	64	285.21	133	89
B72- 14M-115	9A	3535	72	320.87	133	89
B80- 14M-115	9A	3535	80	356.52	133	89
B90- 14M-115	9A	3535	90	401.08	133	89
B112-14M-115	9A	3535	112	499.12	133	89
B144 14M-115	9A	4040	144	641.73	133	102
B168- 14M-115	9A	4040	168	748.69	133	102
B192- 14M-115	9A	4040	192	855.64	133	102
B212- 14M-115	9A	4040	212	944.77	133	102



HTD TİP BURÇLU TRİGER DİŞLİLER

HTD 14M (14 mm) ADIMLI TRİGER DİŞLİLER

HDT 14 M-85						
KOD CODE	TİP TYPE	BURÇ NO TAPER BUSH	Z	DP	F	L
B28- 14M-85F	4FB	2517	28	124.78	102	42
B29- 14M-85F	4FB	2517	29	129.24	102	42
B30- 14M-85F	4FB	2517	30	133.69	102	42
B32- 14M-85F	4FB	2517	32	142.61	102	42
B34- 14M-85F	4FB	2517	34	151.52	102	42
B36- 14M-85F	4FB	3020	36	160.43	102	51
B38- 14M-85F	4FB	3020	38	169.35	102	51
B40- 14M-85F	4FB	3020	40	178.26	102	51
B48- 14M-85F	4FB	3030	48	213.91	102	76
B56- 14M-85F	4FB	3535	56	249.56	102	89
B64- 14M-85F	5FW	3535	64	285.21	102	89
B72- 14M-85	9A	3535	72	320.87	102	89
B80- 14M-85	9A	3535	80	356.52	102	89
B90- 14M-85	9A	3535	90	401.08	102	89
B112-14M-85	9A	3535	112	499.12	102	89
B144 14M-85	9A	3535	144	641.73	102	89
B168- 14M-85	9A	3535	168	748.69	102	89
B192- 14M-85	9A	4040	192	855.64	102	102
B212- 14M-85	9A	4040	212	944.77	102	102

HDT 14 M-115						
KOD CODE	TİP TYPE	BURÇ NO TAPER BUSH	Z	DP	F	L
B28- 14M-115F	4FB	2517	28	124.78	133	42
B29- 14M-115F	4FB	2517	29	129.24	133	42
B30- 14M-115F	4FB	2517	30	133.69	133	42
B32- 14M-115F	4FB	2517	32	142.61	133	42
B34- 14M-115F	4FB	2517	34	151.52	133	42
B36- 14M-115F	4FB	3020	36	160.43	133	51
B38- 14M-115F	4FB	3020	38	169.35	133	51
B40- 14M-115F	4FB	3020	40	178.26	133	51
B48- 14M-115F	4FB	3030	48	213.91	133	76
B56- 14M-115F	4FB	3535	56	249.56	133	89
B64- 14M-115F	5FW	3535	64	285.21	133	89
B72- 14M-115	9A	3535	72	320.87	133	89
B80- 14M-115	9A	3535	80	356.52	133	89
B90- 14M-115	9A	3535	90	401.08	133	89
B112-14M-115	9A	3535	112	499.12	133	89
B144 14M-115	9A	4040	144	641.73	133	102
B168- 14M-115	9A	4040	168	748.69	133	102
B192- 14M-115	9A	4040	192	855.64	133	102
B212- 14M-115	9A	4040	212	944.77	133	102