

T 400 PROFİL ALPOLEN® 1000/GUIDES FOR BOTTLING AND PACKAGING

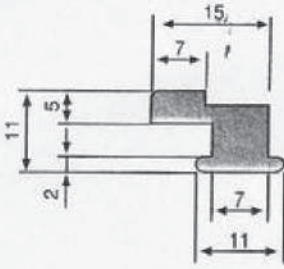

Profil Bölümü/Profiles: "T"

L		Kg/m	Stok Kod Stock Code
2	Alpolen® 1000 - Yeşil / Green	0,11	206 KT1 001
2	Alpolen® 1000 - Siyah / Black	0,11	206 KT1 002

L:Standart Uzunluk(metre)/Standart Length(meter)

T 400 PROFİL ALPOLEN® 1000/GUIDES FOR BOTTLING AND PACKAGING

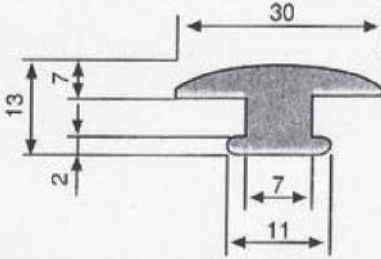

Profil Bölümü/Profiles: "T"

L		Kg/m	Stok Kod Stock Code
2	Alpolen® 1000 - Yeşil / Green	0,24	206 KT2 001
2	Alpolen® 1000 - Siyah / Black	0,24	206 KT2 002

L:Standart Uzunluk(metre)/Standart Length(meter)

ALPOLEN® 1000 T MODEL ZİNCİR KIZAKLARI/ROLLER CHAIN GUIDES

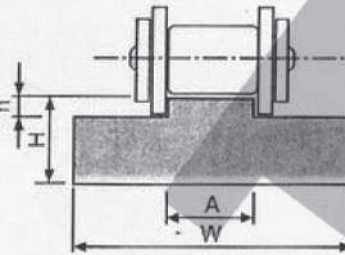
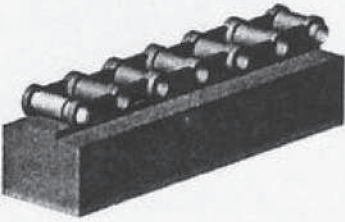

L:Standart Uzunluk (metre/meter)

ISO	(M)	Hatve Pitch	W	H	A	h	L	Kg/m	Stok Kod Stock Code
06 B1	Alpolen® 1000 Yeşil / Green	3/8"	15	10	5,4	1,5	2	0,135	207 OTO 038
08 B1		1/2"	20	10	7,4	2,2	2	0,165	207 OTO 012
08 B1		1/2"	20	15	7,4	2,2	2	0,265	207 OTO 112
10 B1		5/8"	20	10	9,2	2,6	2	0,160	207 OTO 058
10 B1		5/8"	20	15	9,2	2,6	2	0,260	207 OTO 158
12 B1		3/4"	25	10	11,3	2,4	2	0,210	207 OTO 034
12 B1		3/4"	25	15	11,3	2,4	2	0,325	207 OTO 134
16 B1		1"	40	15	16,5	3,5	2	0,470	207 OTO 100
16 B1		1"	40	20	16,5	3,5	2	0,660	207 OTO 101
20 B1		1 1/4"	45	15	19,0	4,3	2	0,530	207 OTO 114
20 B1		1 1/4"	45	20	19,0	4,3	2	0,720	207 OTO 214
24 B1		1 1/2"	60	15	24,6	5,6	2	0,785	207 OTO 412
28 B1		1 3/4"	75	20	30	6,9	2	1,130	207 OTO 434
32 B1		2"	85	20	30	7,8	2	1,210	207 OTO 200

ALPOLEN® 1000 KANALLI T MODEL ZİNCİR KIZAKLARI/ROLLER CHAIN GUIDES

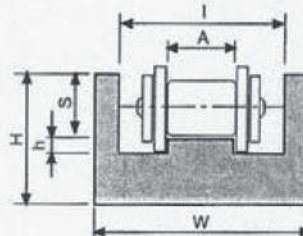

L:Standart Uzunluk (metre/meter)

ISO	(M)	Hatve Pitch	W	H	I	h	A	S	L	Kg/m	Stok Kod Stock Code
06 B1	Alpolen® 1000 Yeşil / Green	3/8"	25	10	15	1,5	5,4	4,4	2	0,170	207 OT2 038
08 B1		1/2"	30	15	20	2,2	7,4	7,2	2	0,275	207 OT2 012
10 B1		5/8"	33	20	23	2,6	9,2	9,5	2	0,405	207 OT2 058
12 B1		3/4"	38	20	28	2,4	11,3	11,1	2	0,410	207 OT2 034
16 B1		1"	51	25	41	3,5	16,5	16,5	2	0,510	207 OT2 100
20 B1		1 1/4"	56	30	46	4,3	19	20,7	2	0,720	207 OT2 114

ALPOLEN® 1000 2T MODEL HAFİF TİP ZİNCİR KIZAKLARI/ROLLER CHAIN GUIDES (LIGHT TYPE)

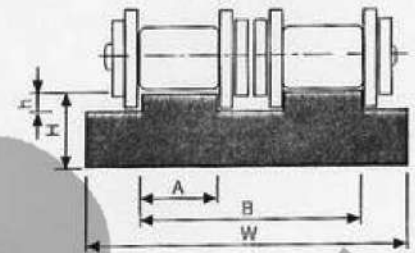
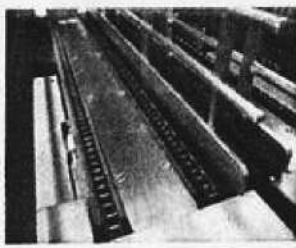
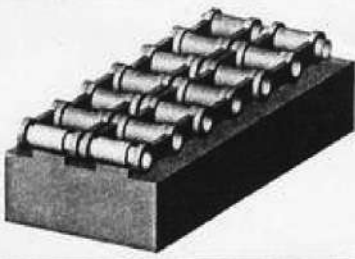

L: Standart Uzunluk/Length (metre/meter)

ISO	Tip/Type	(M)	Hatve/Pitch	W	H	A	h	B	Kg/m	L	Stok Kod Stock Code
06 B2	Hafif Tip Light Type	Alpolen® 1000 Yeşil / Green	3/8"	25	10	5,4	1,5	16	0,230	2	207 TH2 510
08 B2			1/2"	35	10	7,4	2,2	21	0,306	2	207 TH3 510
10 B2			5/8"	40	10	9,2	2,6	26	0,344	2	207 TH4 010
10 B2			5/8"	40	15	9,2	2,6	26	0,524	2	207 TH4 015
12 B2			3/4"	45	10	11,3	2,4	31	0,396	2	207 TH4 510
12 B2			3/4"	45	15	11,3	2,4	31	0,598	2	207 TH4 515

ALPOLEN® 1000 2T MODEL AĞIR TİP ZİNCİR KIZAKLARI/ROLLER CHAIN GUIDES (HEAVY TYPE)

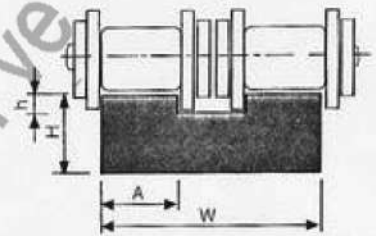
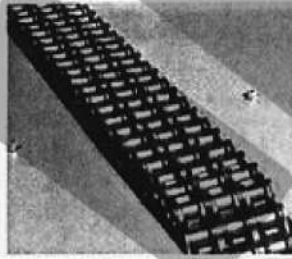
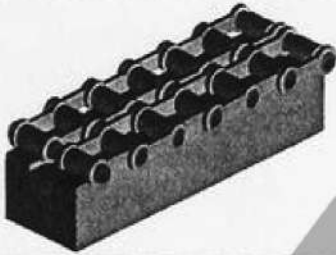

L: Standart Uzunluk/Length (metre/meter)

ISO	Tip/Type	(M)	Hatve/Pitch	W	H	A	h	B	Kg/m	L	Stok Kod Stock Code
16 B2	Ağır Tip Heavy Type	Alpolen® 1000 Yeşil / Green	1"	48	15	16,5	3,5	-	0,863	2	207 TA4 815
16 B2			1"	48	20	16,5	3,5	-	1,156	2	207 TA4 820
20 B2			1 1/4"	55	15	19	4,3	-	0,912	2	207 TA5 515
20 B2			1 1/4"	55	20	19	4,3	-	1,232	2	207 TA5 520
24 B2			1 1/2"	72	20	24,6	5,6	-	1,499	2	207 TA7 220
28 B2			1 3/4"	89	20	30	6,9	-	1,790	2	207 TA8 920
32 B2			2"	89	20	30	7,8	-	1,750	2	207 TA8 921

"TT" ZİNCİR KIZAKLARI/"TT" ROLLER CHAIN GUIDES

Stok Kod/Stock Code
765 045 150

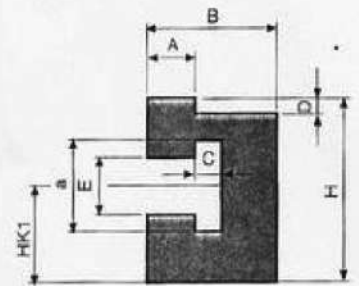
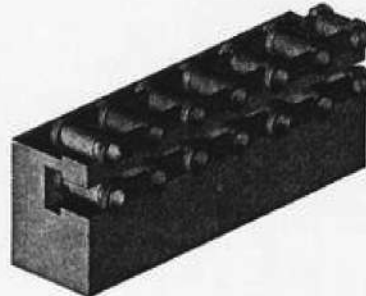
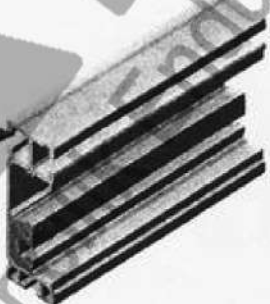

Profil Bölümü/Profiles: "TT"

(M)	Hatve Pitch	a	A	C	D	E	B	H	Hq	HK1	Stok Kod Stock Code
Alpolen® 1000 Yeşil / Green	3/8"	9,5	5,4	4,6	1,5	6,6	20,0	24,4	26,9	14,5	207 0TT 001
	1/2"	13,0	7,4	5,4	2,2	8,6	20,0	26,9	29,4	15,5	207 0TT 002
	5/8"	15,5	9,2	5,6	2,6	10,4	20,0	33,8	36,2	18,5	207 0TT 003
	3/4"	17,0	11,3	6,4	2,6	12,2	28,0	37,3	40,3	21,5	207 0TT 004
	1/1"	22,0	16,5	10,5	4,2	16,0	38,0	50,5	54,0	31,5	207 0TT 005

L: Standart Uzunluk (metre)/Standart Length (meter)

ALPOLEN® 1000 3 SIRALI ZİNCİR KIZAKLARI/ROLLER CHAIN GUIDES (TRIPLE)

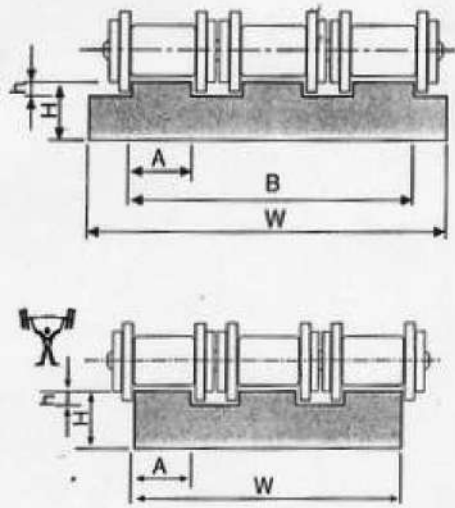

Profil Bölümü:"3T"

ISO	(M)	Hatve Pitch	W	H	A	h	B	L	Kg/m	Stok Kod Stock Code
06 B3	Alpolen® 1000 Yeşil/Green	3/8"	35	10	5,4	1,5	25,9	2	0,306	207 B33 510
08 B3		1/2"	45	10	7,4	2,2	35,3	2	0,381	207 B34 510
08 B3		1/2"	45	15	7,4	2,2	35,3	2	0,595	207 B34 515
08 B3		1/2"	45	20	7,4	2,2	35,3	2	0,808	207 B34 520
10 B3		5/8"	55	10	9,2	2,6	42,5	2	0,455	207 B35 510
12 B3		3/4"	65	10	11,3	2,4	50,3	2	0,546	207 B36 510
16 B3	1"	95	15	16,5	3,5	80,3	2	1,167	207 B39 515	
20 B3	Alpolen® 1000 Yeşil/Green	1 1/4"	92	15	19,0	4,3	92,0	2	1,304	207 B39 215
24 B3		1 1/2"	121	20	24,6	5,6	121,5	2	2,247	207 B31 120
28 B3		1 3/4"	149	25	30,0	6,9	149,3	2	3,522	207 B31 925
32 B3		2"	149	30	30,0	7,8	149,3	2	4,262	207 B31 930

L: Standart Uzunluk (metre)/Standart Length (meter)

ALPOLEN® 1000 "UCD" ZİNCİR KIZAKLARI/ROLLER CHAIN GUIDES "UCD"

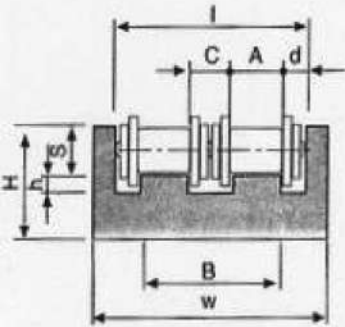

Profil Bölümü:"UCD"

ISO	(M)	Hatve Pitch	W	H	I	h	A	S	B	C	d	L	Kg/m	Stok Kod Stock Code
06 B2	Alpolen® 1000 Yeşil/Green	3/8"	36		26		5,4		16		5		0,390	207 UCD 036
08 B2		1/2"	45		35		7,4		21		7		0,620	207 UCD 045
10 B2		5/8"	50		40		9,2		26		7		0,816	207 UCD 050
12 B2		3/4"	56		46		11,3		31		7,5		0,810	207 UCD 056
16 B2		1"	85		75		16,5		48,4		13,3		1,200	207 UCD 085

L: Standart Uzunluk (metre)/Standart Length (meter)

ALPOLEN® 1000 "UCC" ZİNCİR KIZAKLARI/ROLLER CHAIN GUIDES "UCC"

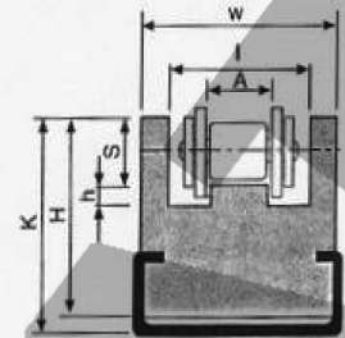

Profil Bölümü:"UCC"

ISO	(M)	Hatve Pitch	Kılavuz Guide	W	H	K	I	h	A	S	L	Kg/m	Stok Kod Stock Code
06 B1	Alpolen® 1000 Yeşil/Green	3/8"	C 2010 ZN	25	15	18	15	1,5	5,4	4,4	2	0,760	207 UCC C25
06 B1		3/8"	C 2010 SS	25	15	18	15	1,5	5,4	4,4	2	0,760	207 UCC P25
08 B1		1/2"	C 2812 ZN	30	25	27	20	2,2	7,4	7,2	2	1,100	207 UCC C30
08 B1		1/2"	C 2812 SS	30	25	27	20	2,2	7,4	7,2	2	1,100	207 UCC P30
10 B1		5/8"	C 2812 ZN	33	30	32	23	2,6	9,2	9,5	2	1,305	207 UCC C33
10 B1		5/8"	C 2812 SS	33	30	32	23	2,6	9,2	9,5	2	1,305	207 UCC P33
12 B1		3/4"	C 3818 ZN	38	35	40	28	2,4	11,3	11,1	2	2,335	207 UCC C38
12 B1		3/4"	C 3818 SS	38	35	40	28	2,4	11,3	11,1	2	2,335	207 UCC P38
16 B1		1"	C 3818 ZN	51	40	45	41	3,5	16,5	16,5	2	2,440	207 UCC C51
16 B1		1"	C 3818 SS	51	40	45	41	3,5	16,5	16,5	2	2,440	207 UCC P51

L: Standart Uzunluk (metre)/Standart Length (meter)

ALPOLEN® 1000 "TCG" ZİNCİR KIZAKLARI/ROLLER CHAIN GUIDES "TCG"

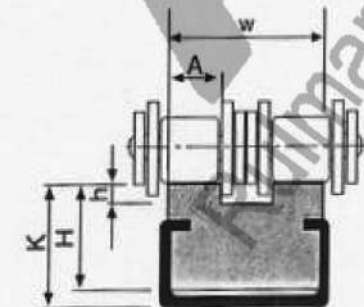

Profil Bölümü:"UCC"

ISO	(M)	Hatve Pitch	Kılavuz Guide	W	H	K	h	A	L	Kg/m	Stok Kod Stock Code
06 B2	Alpolen® 1000 Yeşil/Green	3/8"	C 2010 ZN	20	10	15	1,5	5,4	2	0,615	207 TCG C38
06 B2		3/8"	C 2010 SS	20	10	15	1,5	5,4	2	0,615	207 TCG P38
08 B2		1/2"	C 2010 ZN	21,5	15	17	2,2	7,4	2	0,715	207 TCG C12
08 B2		1/2"	C 2010 SS	21,5	15	17	2,2	7,4	2	0,715	207 TCG P12
10 B2		5/8"	C 2812 ZN	28	15	17	2,6	9,2	2	1,165	207 TCG C58
10 B2		5/8"	C 2812 SS	28	15	17	2,6	9,2	2	1,165	207 TCG P58
12 B2		3/4"	C 2812 ZN	31	15	18	2,4	11,3	2	1,200	207 TCG C34
12 B2		3/4"	C 2812 SS	31	15	18	2,4	11,3	2	1,200	207 TCG P34

L: Standart Uzunluk (metre)/Standart Length (meter)

ALPOLEN® 1000 TT MODEL TİPİ ZİNCİR KIZAKLARI/ROLLER CHAIN GUIDES

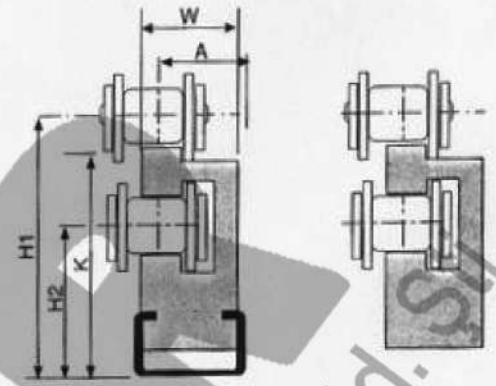
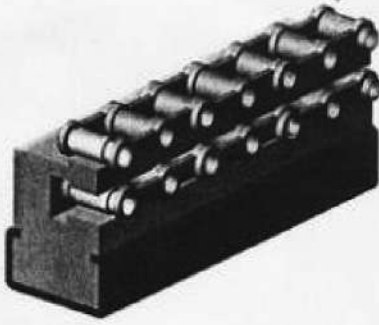

ISO	Hatve Pitch	(M)	W	H	H1	H2	A	K	Kılavuz Guide	L	Kg/m	Stok Kod Stock Code
06 B1	3/8"	Alpolen® 1000 Yeşil / Green	20	25	30	17	14,5	27	C 2010 ZN	2	0,900	207 1TT C38
06 B1	3/8"		20	25	30	17	14,5	27	C 2010 SS	2	0,900	207 1TT P38
08 B1	1/2"		20	28	34	18	16,5	30	C 2010 ZN	2	0,960	207 1TT C12
08 B1	1/2"		20	28	34	18	16,5	30	C 2010 SS	2	0,960	207 1TT P12
10 B1	5/8"		20	33	41	21	15,5	36	C 2010 ZN	2	1,120	207 1TT C58
10 B1	5/8"		20	33	41	21	15,5	36	C 2010 SS	2	1,120	207 1TT P58
12 B1	3/4"		28	37	46,5	24	18,6	41	C 2812 ZN	2	1,700	207 1TT C34
12 B1	3/4"		28	37	46,5	24	18,6	41	C 2812 SS	2	1,700	207 1TT P34
16 B1	1"		38	51	62	34	25	54	C 3818 ZN	2	3,100	207 1TT C01
16 B1	1"		38	51	62	34	25	54	C 3818 SS	2	3,100	207 1TT P01

ALPOLEN® 1000 CC MODEL ÇELİK PROFİLLİ ZİNCİR KIZAKLARI/ROLLER CHAIN GUIDES

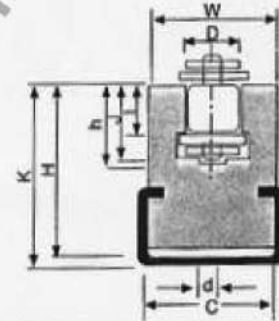
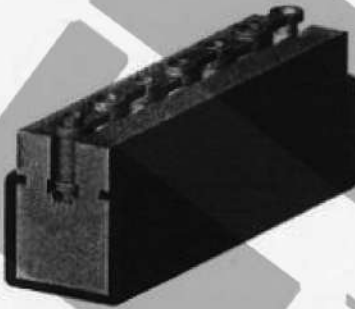

ISO	Hatve Pitch	Kılavuz Guide	(M)	W	H	K	I	J	h	d	D	C	L	Kg/m	Stok Kod Stock Code
06 B	3/8"	C 2010 ZN	Alpolen® 1000 Yeşil / Green	20	17,5	21	5,6	8,7	9,9	4	6,6	9,3	2	0,622	207 ALC 038
06 B	3/8"	C 2010 SS		20	17,5	21	5,6	8,7	9,9	4	6,6	9,3	2	0,622	207 ALP 038
08 B	1/2"	C 2812 ZN		28	27,5	32	7,6	11,5	12,7	5	8,7	12,8	2	1,450	207 ALC 012
08 B	1/2"	C 2812 SS		28	27,5	32	7,6	11,5	12,7	5	8,7	12,8	2	1,450	207 ALP 012
10 B	5/8"	C 2812 ZN		28	27,5	32	9,3	13,5	14,8	6	10,4	15,4	2	1,402	207 ALC 058
10 B	5/8"	C 2812 SS		28	27,5	32	9,3	13,5	14,8	6	10,4	15,4	2	1,402	207 ALP 058
12 B	3/4"	C 3818 ZN		38	34,0	43	11,5	15,9	17,5	7	12,3	16,9	2	1,709	207 ALC 034
12 B	3/4"	C 3818 SS		38	34,0	43	11,5	15,9	17,5	7	12,3	16,9	2	1,709	207 ALP 034
16 B	1"	C 3818 ZN		38	40	50	15,9	25,7	28,2	9	16,2	24,4	2	1,600	207 ALC 100
16 B	1"	C 3818 SS		38	40	50	15,9	25,7	28,2	9	16,2	24,4	2	1,600	207 ALP 100
20 B	1 1/4"	C 6020 ZN		60	45	55	19,4	29,3	31,2	11	19,3	27,5	2	4,800	207 ALC 114
20 B	1 1/4"	C 6020 SS		60	45	55	19,4	29,3	31,2	11	19,3	27,5	2	4,800	207 ALP 114
24 B	1 1/2"	C 6020 ZN		60	55	65	25,2	38,2	40,1	16	25,7	36,5	2	5,000	207 ALC 112
24 B	1 1/2"	C 6020 SS		60	55	65	25,2	38,2	40,1	16	25,7	36,5	2	5,000	207 ALP 112
28 B	1 3/4"	C 6020 ZN		70	70	80	30,8	46,9	48,9	17	28,3	41,5	2	6,200	207 ALC 134
28 B	1 3/4"	C 6020 SS		70	70	80	30,8	46,9	48,9	17	28,3	41,5	2	6,200	207 ALP 134
32 B	2"	C 6020 ZN		70	70	80	30,8	47,3	53,0	19	29,6	44,5	2	6,200	207 ALC 200
32 B	2"	C 6020 SS		70	70	80	30,8	47,3	53,0	19	29,6	44,5	2	6,200	207 ALP 200

ALPOLEN® CCZ MODEL ÇELİK PROFİLLİ ZİNCİR KIZAKLARI/ROLLER CHAIN GUIDES

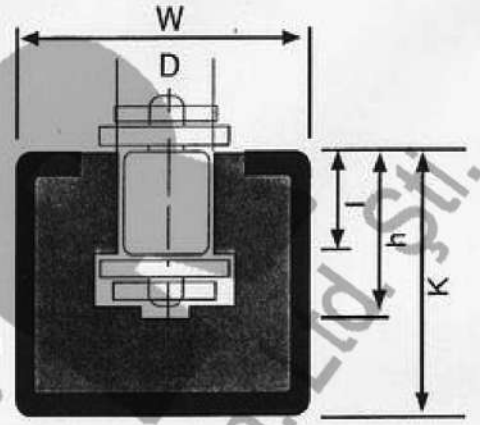
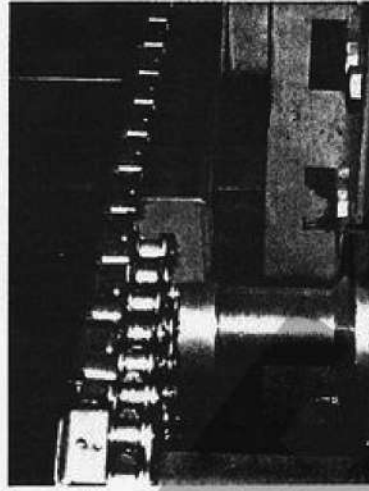
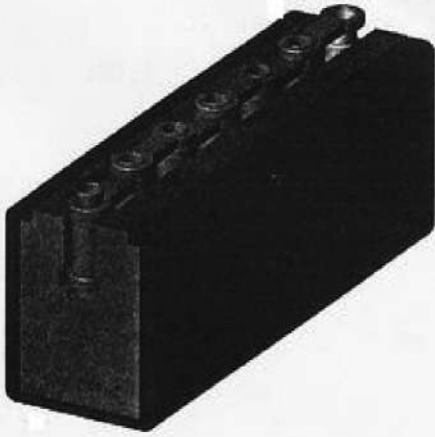

ISO	Hatve/Pitch	(M)	W	K	h	I	D	Kılavuz Guide	L	Kg/m	Stok Kod Stock Code
06 B	3/8"	Alpolen® 1000 Yeşil / Green	30	24	10,0	5,6	6,6	C3024 ZN	2	1,375	207 CCZ 038
06 B	3/8"		30	24	10,0	5,6	6,6	C3024 SS	2	1,375	207 CCZ 138
08 B	1/2"		30	24	12,7	7,6	8,7	C3024 ZN	2	1,350	207 CCZ 012
08 B	1/2"		30	24	12,7	7,6	8,7	C3024 SS	2	1,350	207 CCZ 112
08 B	1/2"		28	16	12,7	7,6	8,7	C2816 ZN	2	1,260	207 CCZ 212
08 B	1/2"		28	16	12,7	7,6	8,7	C2816 SS	2	1,260	207 CCZ 312
10 B	5/8"		30	24	14,8	9,3	10,4	C3024 ZN	2	1,300	207 CCZ 058
10 B	5/8"		30	24	14,8	9,3	10,4	C3024 SS	2	1,300	207 CCZ 158
12 B	3/4"		30	24	17,5	11,5	12,3	C3024 ZN	2	1,260	207 CCZ 034
12 B	3/4"		30	24	17,5	11,5	12,3	C3024 SS	2	1,260	207 CCZ 134
16 B	1"		45	40	28,2	15,9	16,2	C4540 ZN	2	2,930	207 CCZ 100
16 B	1"		45	40	28,2	15,9	16,2	C4540 SS	2	2,930	207 CCZ 101

ALPOLEN® 1000 MODEL BL TİPİ ZİNCİR KIZAKLARI/ROLLER CHAIN GUIDES

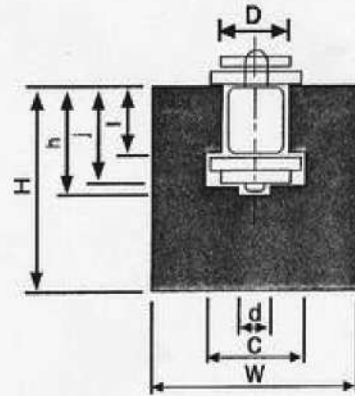

ISO	Hatve/Pitch	(M)	W	H	C	h	I	D	J	d	L	Kg/m	Stok Kod Stock Code
06 B	3/8"*7/32"	Alpolen® 1000 Yeşil / Green	20	25	9,3	10	5,6	6,6	8,7	4	2	0,414	207 BLO 038
08 B	1/2"*5/16"		24	30	12,8	12,7	7,6	8,7	11,5	5	2	0,564	207 BL1 012
10 B	5/8"*3/8"		30	35	15,4	14,8	9,5	10,4	13,5	6	2	0,832	207 BL2 058
12 B	3/4"*7/16"		40	35	16,9	17,5	11,5	12,3	15,9	7	2	1,106	207 BL3 034
16 B	1"*17mm		40	45	24,4	28,2	15,9	16,2	25,7	9	2	1,231	207 BL4 001
20 B	1 1/4"*3/4"		50	50	27,5	31,2	19,4	19,3	29,3	11	2	1,726	207 BL5 114
24 B	1 1/2"*1"		60	60	36,5	40,1	25,2	25,7	38,2	16	2	2,332	207 BL6 112
28 B	1 3/4"*31mm		70	70	41,5	48,9	30,8	28,3	46,9	17	2	3,173	207 BL7 134
32 B	2"*31mm		75	75	44,5	53,0	30,8	29,6	47,3	19	2	3,264	207 BL8 002

ALPOLEN® 1000 U MODEL ÇELİK PROFİLLİ ZİNCİR KIZAKLARI/ROLLER CHAIN GUIDES

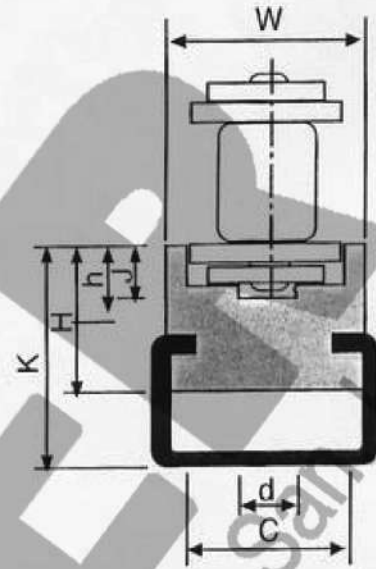
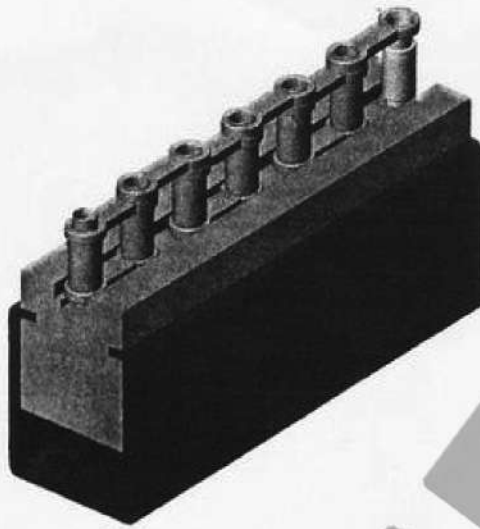

L:Standart Uzunluk (metre/meter)

ISO	(M)	Hatve/Pitch	W	H	K	h	J	d	Klavuz Guide	L	Kg/m	Stok Kod Stock Code
06 B1	Alpolen® 1000 Yeşil / Green	3/8"	20	10	15	4,2	2,8	4	C 2010 ZN	2	0,720	207 CUO 038
06 B1		3/8"	20	10	15	4,2	2,8	4	C 2010 SS	2	0,720	207 CUO 138
08 B1		1/2"	25	15	22	4,8	3,5	5	C 2812 ZN	2	1,140	207 CUO 012
08 B1		1/2"	25	15	22	4,8	3,5	5	C 2812 SS	2	1,140	207 CUO 112
10 B1		5/8"	25	15	22	5,1	3,6	6	C 2812 ZN	2	1,130	207 CUO 058
10 B1		5/8"	25	15	22	5,1	3,6	6	C 2812 SS	2	1,130	207 CUO 158
12 B1		3/4"	25	20	27	5,7	3,9	7	C 2812 ZN	2	1,270	207 CUO 034
12 B1		3/4"	25	20	27	5,7	3,9	7	C 2812 SS	2	1,270	207 CUO 134
16 B1		1"	35	25	33	10	8,4	9	C 3818 ZN	2	2,030	207 CUO 100
16 B1		1"	35	25	33	10	8,4	9	C 3818 SS	2	2,030	207 CUO 101

ALPOLEN® 1000 U ZİNCİR KIZAKLARI/ROLLER CHAIN GUIDES

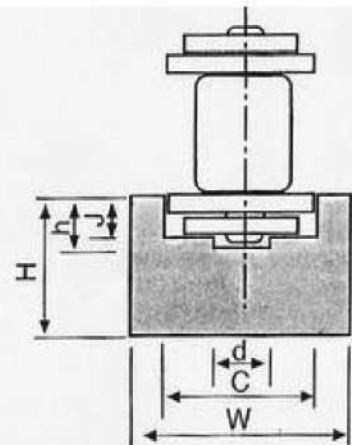
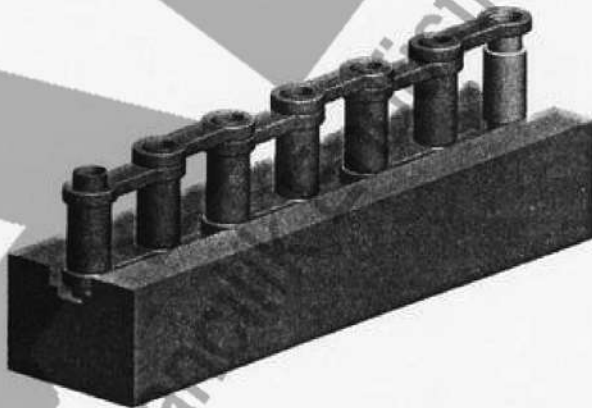

L:Standart Uzunluk (metre/meter)

ISO		Hatve/Pitch	W	H	C	h	J	d	L	Kg/m	Stok Kod Stock Code
06 B	Alpolen® 1000 Yeşil / Green	3/8"*7/32"	20	15	9,2	4,2	2,8	4	2	0,257	207 0U0 038
08 B		1/2"*5/16"	25	15	12,7	4,8	3,5	5	2	0,308	207 0U1 012
10 B		5/8"*3/8"	25	15	15,2	5,1	3,6	6	2	0,296	207 0U2 058
12 B		3/4"*7/16"	25	20	16,7	5,7	3,9	7	2	0,430	207 0U3 034
16 B		1"*17mm	35	25	24,4	10	8,4	9	2	0,624	207 0U4 001

ALPOLEN® 1000 U DÜZ BANTLAR İÇİN ÇELİK PROFİLLİ ZİNCİR KIZAKLARI/STRAIGHT CHAIN GUIDES

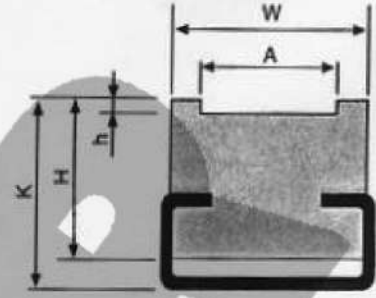
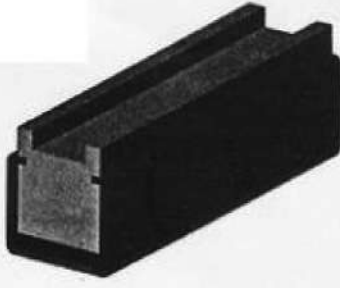

K :
 H :
 h :
 W :
 A :

Ⓜ	Klavuz Guide	L	Kg/m	Stok Kod Stock Code
Alpolen® 1000 Yeşil / Green	ZN	2	-	207 TUO 001
	SS	2	-	207 TUO 002

*LÜTFEN ÖLÇÜLERİ DOLDURARAK TALEPTE BULUNUNUZ. / TO MAKE AN ORDER INDICATE DIMENSIONS

ALPOLEN® 1000 T MODEL ÇELİK PROFİLLİ ZİNCİR KIZAKLARI/ROLLER CHAIN GUIDES

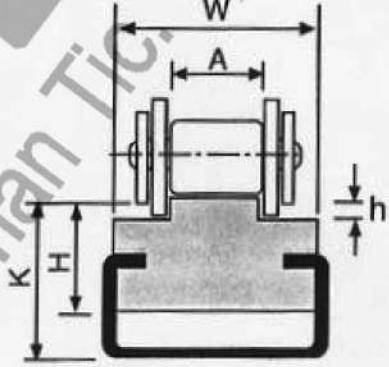
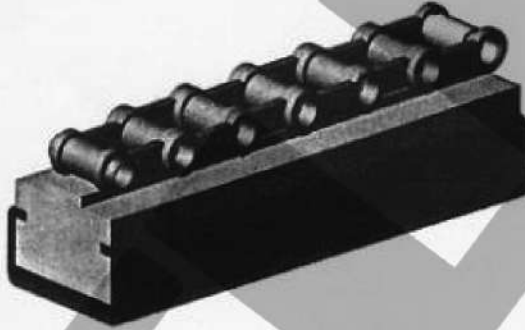

L:Standart Uzunluk (metre/meter)

ISO	Ⓜ	Hatve/Pitch	W	H	K	h	A	Klavuz Guide	L	Kg/m	Stok Kod Stock Code
06 B1	Alpolen® 1000 Yeşil / Green	3/8"	20	15	17	1,5	5,4	C 2010 ZN	2	0,620	207 H15 038
06 B1		3/8"	20	15	17	1,5	5,4	C 2010 SS	2	0,620	207 H15 138
08 B1		1/2"	20	15	17	2,2	7,4	C 2010 ZN	2	0,695	207 H15 012
08 B1		1/2"	20	15	17	2,2	7,4	C 2010 SS	2	0,695	207 H15 112
10 B1		5/8"	20	15	17	2,6	9,2	C 2010 ZN	2	0,700	207 H15 058
10 B1		5/8"	20	15	17	2,6	9,2	C 2010 SS	2	0,700	207 H15 158
12 B1		3/4"	28	15	18	2,4	11,3	C 2812 ZN	2	1,170	207 H15 034
12 B1		3/4"	28	15	18	2,4	11,3	C 2812 SS	2	1,170	207 H15 134
16 B1		1"	28	20	24	3,5	16,5	C 2812 ZN	2	2,245	207 H20 100
16 B1		1"	28	20	24	3,5	16,5	C 2812 SS	2	2,245	207 H20 101
16 B1		1"	28	15	18	3,5	16,5	C 2812 ZN	2	1,250	207 H15 100
16 B1		1"	28	15	18	3,5	16,5	C 2812 SS	2	1,250	207 H15 101
20 B1		1 1/4"	38	25	30	4,3	19,0	C 3818 ZN	2	2,305	207 H25 114
20 B1		1 1/4"	38	25	30	4,3	19,0	C 3818 SS	2	2,305	207 H25 214
24 B1		1 1/2"	38	25	30	5,6	24,6	C 3818 ZN	2	2,390	207 H25 112
24 B1		1 1/2"	38	25	30	5,6	24,6	C 3818 SS	2	2,390	207 H25 212
28 B1		1 3/4"	38	25	30	6,9	30	C 3818 ZN	2	2,410	207 H25 134
28 B1		1 3/4"	38	25	30	6,9	30	C 3818 SS	2	2,410	207 H25 234
32 B1		2"	38	25	30	7,8	30	C 3818 ZN	2	2,480	207 H25 200
32 B1		2"	38	25	30	7,8	30	C 3818 SS	2	2,480	207 H25 201